

107489

1984

ANNUAL

STATISTICAL REPORT

MDC

MOVING FORWARD

U.S. Department of Justice
National Institute of Justice

This document has been reproduced exactly as received from the person or organization originating it. Points of view or opinions stated in this document are those of the authors and do not necessarily represent the official position or policies of the National Institute of Justice.

Permission to reproduce this copyrighted material has been granted by
Michigan Department of
Corrections

to the National Criminal Justice Reference Service (NCJRS).

Further reproduction outside of the NCJRS system requires permission of the copyright owner.

MICHIGAN DEPARTMENT OF CORRECTIONS

1984

Statistical Presentation

Governor James Blanchard
Corrections Director Robert Brown Jr.

CORRECTIONS COMMISSION

Gwen Andrew, Ph.D.
Brunetta Brandy
Thomas K. Eardley Jr.
James H. Lincoln
Duane Waters, M.D.

Editor: Gail R. Light

Distributed Fall, 1985

FOREWORD

The statistical data in this report came primarily from information systems maintained by the Data Processing Division within the Bureau of Administrative Services. Information in Court Dispositions came from the various felony courts in Michigan.

Additional information on the production and content of this publication can be obtained by contacting the Public Information Office, Michigan Department of Corrections, Stevens T. Mason Building, Lansing, Michigan 48909.

ACKNOWLEDGEMENT

The editor gratefully acknowledges the contributions of the following persons in the preparation of the 1984 statistical presentation:

Stephen Malatinsky, graphic designer, who designed and produced the charts and tables.

Connie Henslee, Administrative Manager, who collected and prepared the statistical data.

Steven Paddock, Data Processing Division, who coordinated information systems.

Sue Bierwagen, who keyed the text.

--Gail R. Light

TABLE OF CONTENTS

FOREWORD		i
ACKNOWLEDGEMENTS		ii
DEPARTMENTAL ORGANIZATION CHART		1
1984 IN REVIEW		2
COURT DISPOSITIONS		4
- Court Dispositions by Districts		6
- 1984 Court Dispositions by Groups		7
- Court Dispositions by Type		9
- Court Disposition: 5-Year Comparison		15
PRISON COMMITMENTS		16
- Commitments Compared with Prison Population and Census		17
- Reported Crimes Versus Commitments		18
- Commitments and Minimum Term Distribution		19
- Female Commitments and Minimum Term Distribution		24
- Commitments by Age for Men		27
- Commitments, Breakdown by Age, Sex, Race		28
- Commitments by Race for Men		29
- Commitments by Race; Male and Female		29
- Commitments by Type		30
- Commitments: Percent of Crime		30
- Commitments: Five-Year Comparison		30
PRISONS AND PRISONERS		31
- Prisoner Population and Minimum Term Distribution		32
- Female Prisoner Population and Minimum Term Distribution		37
- Racial Composition		38
- Facilities Summary		39
- Critical Incidents		40
- Facility Populations		41
- Institutional Programs		42
- Map of Facilities		43
- Description of Institutions		44
- Prison Population and Rated Capacity		46
- Michigan State Industries		
- Total Prisoner Earnings		47
- Five-Year Sales History - Three Largest Factories		48
- Prisoners Employed During 1984		49
- Prisoner Wages, Bonuses, Man Hours, Sales		49
- Major Misconducts Year Totals		50
- Age Breakdown of Total Population		51

NCJRS
MAY 25 1985
ACQUISITIONS

PAROLE	52
- Parole Board Action for 1984	54
- Place of Hearing	54
- Follow-up Study of First Parole for 1980 by Offense Groups	55
- 1980 Parolees Returned: Original Crime Type Versus New Crime Type	56
FIELD SERVICES	57
- Map - Bureau of Field Services Regions and Areas	59
- Parole Violations	60
- Personnel and Funds Distribution	61
- Work Unit Distribution	62
- Probation Terminations	63
- Disposition of Probation Violations 1980-84	63
- Parole Terminations	64
- Average Number of Parole Cases Supervised	64
- Average Number of Probationers Under Supervision	65
- Community Alternative Program	65
- Program Funding	66
- Average Daily Count	67
Community Corrections Program	68
- Basic Statistics 1980-84 Fiscal Year	69
- Program Terminations	70
- Average Daily Count	71
- Prisoner Earnings	72
- Terminations	74
FINANCE	75
- Expenditures by Units	76
- Expenditure Areas	76
PERSONNEL	77
LITIGATION BY YEAR	83

CORRECTIONS COMMISSION
 Gwen Andrew, Ph. D.
 Brunetta Brandy
 Thomas K. Eardley, Jr.
 James H. Lincoln
 Duane L. Waters, M. D.

MEDICAL POLICY COMMITTEE

EXECUTIVE ASSISTANT
 Richard McKeon

DIRECTOR
 Robert Brown, Jr.

POLICY AUDITOR John Whelan
PRISONER AFFAIRS Gerald Hofbauer
PUBLIC INFORMATION Gail Light
HEARINGS DIVISION Marjorie VanOchten
CONSENT DECREE MONITORING Luella Burke

PAROLE BOARD Chairman William Hudson
BUREAU OF CORRECTIONAL FACILITIES Deputy Director Dan Bolden
BUREAU OF PROGRAMS Deputy Director William Kime
BUREAU OF ADMINISTRATIVE SERVICES Deputy Director Alvin Whitfield
BUREAU OF PRISON INDUSTRIES Deputy Director Howard Gentry
BUREAU OF FIELD SERVICES Deputy Director Perry Johnson
OFFICE OF HEALTH CARE Director (Vacant)

ASST. DEPUTY DIRECTOR PROGRAMS Rudolf Stahberg
ASST. DEPUTY DIRECTOR OPERATIONS Donald Houseworth
OFFICE OF FACILITY SERVICES Jeff Eubank
ADMINISTRATIVE SYSTEMS Gary Boertz
OPERATIONS Asst. Deputy Director William Overton
COMMUNITY PROGRAMS Asst. Deputy Director Jimmy Putnam

Associate Director
 K. L. Falver M.L./I.R.. M.P.H.

HURON VALLEY WOMENS FACILITY Superintendent Tekla Miller
CAMP PROGRAM Superintendent William Grant
CASSIDY LAKE Superintendent John Staten
HURON VALLEY MENS FACILITY Warden Robert Redman
PHOENIX CORRECTIONAL FACILITY Superintendent Lloyd May
WESTERN WAYNE CORR. FACILITY Superintendent Emmett Baylor
MUSKEGON CORR. FACILITY Superintendent H. Gary Wells
MICH. TRAINING UNIT Superintendent James Yarborough
MICHIGAN REFORMATORY Warden John Jabe
MICH. DUNES Superintendent Pam Withrow
RIVERSIDE CORR. FACILITY Superintendent Denise Quarles
KINROSS CORR. FACILITY Superintendent Robert LeCureux
MARQUETTE BRANCH PRISON Warden Theodore Koehler
MICH. INTENSIVE PROGRAM CENTER Superintendent Jack Bergman
FLORENCE CRANE CORR. FACILITY Superintendent Carol Howes
RIVERSIDE RECEPTION CENTER Administrator Robert Mayer
STATE PRISON OF SOUTHERN MICHIGAN Warden Dale Foltz
RECEPTION & GUIDANCE CENTER Superintendent John Prelesnik
CENTRAL COMPLEX Deputy Elton Scott
NORTH COMPLEX Deputy Joe Weinberg
SOUTH COMPLEX Deputy Charles Anderson

BUDGET Lewis Bozek
FINANCE Linda Pigue
DATA PROCESSING William Leach
PERSONNEL & TRAINING Jack Boyett
PHYSICAL PLANT UNIT Bob Groenleer

COMMUNITY ALTERNATIVES Don Hengesh
REGION I Administrator Edward Nakfoor
REGION II Administrator John Belson
REGION III Administrator Dale May

MENTAL HEALTH Asst. Director Robert Ort M.D. Ph. D.
DENTAL HEALTH Asst. Director Wm. Byland D.D.S.
MEDICINE Asst. Director Vacant
INSTITUTIONAL MEDICAL DIRECTORS

1984 IN REVIEW

The Michigan Department of Corrections saw the beginning of a new administration in 1984. Director Perry M. Johnson resigned that year to take the post of deputy director in charge of the Bureau of Field Services, succeeding Richard K. Nelson, who retired. Twenty-three persons vied for Johnson's position. The State Corrections Commission chose Robert Brown Jr., the deputy director in charge of the Bureau of Correctional Facilities.

Brown's appointment had followed the selection earlier during the year of two new Commission members: James H. Lincoln, a former probate judge from Wayne County, and Brunetta Brandy, an attorney from Detroit. Brandy and Lincoln replaced Don P. LeDuc, dean of the Cooley Law School in Lansing, and G. Robert Cotton, a nursing home owner from Grass Lake who was in ill health.

Shortly after Brown's appointment, public clamor over use of the state's Prison Overcrowding Emergency Powers Act reached a crescendo. An East Lansing police officer and an East Lansing housewife were both shot and killed by persons who had been under the jurisdiction of the department. One of those, a parolee, was released several years early as a result of the Emergency Powers Act and was on parole at the time of the shootings. The other prisoner was a resident of a Lansing halfway house. The deaths of these two persons prompted a serious reexamination of the law which had been used nine times since its enactment in late 1980.

Shortly after the deaths of the East Lansing residents, Gov. James J. Blanchard refused to issue any more emergency declarations under provisions

of the law. He cited safety of the community as the reason for his action and called for a massive prison construction project to meet the needs of the department.

During late 1984, the Emergency Powers Act was revised to allow the Department to develop temporary multiple occupancy housing during 1985 to meet the emergency caused by continued prison crowding. The revision stipulated that the use of such multiple occupancy housing would be discontinued after Jan. 1, 1987. In addition, the State Legislature appropriated about \$16 million to acquire and analyze prison sites, to design and begin construction of new prisons, and to purchase and remodel facilities for prisons in the city of Detroit, counties of Ionia, Lapeer, Wayne, Macomb, Oakland and Jackson. The money also was to be used to construct a second prison at Camp Cusino. An additional \$600,000 was appropriated to hire 21 new field agents to develop innovative alternatives to prison. By the end of 1984, the department had responded to the Governor's decision not to enact the Emergency Powers Act by agreeing to place three prisoners in a room at the Kinross Correctional Facility. A major prison acquisition and construction program was launched early in 1985.

Also during 1984, a major out-of-court settlement between the U.S. Department of Justice and the State of Michigan guaranteed repairs and improvements in the three oldest state prisons over a six-year period at a cost of about \$30 million. The Consent Decree was approved by the U.S. District Court in Kalamazoo on July 22, 1984. Agreement had been reached earlier by the state and the Justice Department.

COURT DISPOSITIONS

The A tables, charts and graphs illustrate data supplied to the department by the Circuit Courts in Michigan and the Detroit Recorder's Court. They show dispositions for all felony convictions handled by the Courts in 1984.

Table A-1 counts the number of people who received court sentences during the year. In 1984 a total of 22,119 people were sentenced for felony crimes. Of those, 6,827 came to prison, about 100 more than in 1983. Of all persons sentenced for felonies in 1984, 52.6% were placed in probation, compared with 55.8% in 1983.

The A-1 table categorizes each person according to the most severe sentences s/he received even though a person may have been sentenced for several felony crimes. An individual is counted more than once if s/he received court sentences on separate occasions three months or more apart.

Pie charts Ala through Ale illustrate the composition of these sentenced offenders. The definitions of the groups accompany the charts. More details on these groups can be obtained from the Office of Public Information. Group A constitutes 29.7% of the 22,119 persons convicted of felonies in 1984. Group A people have no prior jail term, juvenile probation only or one jail term.

Group B constitutes 11.5% and is composed of people with a juvenile record, multiple jail terms or one term of adult probation.

Group C constitutes 37.5% of the total and is made up of persons with multiple probation terms, probation violators or prior prison terms.

Group D, which constitutes 21.4%, is composed of institutional residents, escapees, and parole violators with new sentences.

A2 counts all court dispositions (cases) as opposed to people. By looking at this chart you can tell how many cases of a certain crime got prison, probation or jail. One person may have received several sentences and some sentences involved several dispositions such as probation and jail.

+ + +

A1 1984 COURT DIPOSITIONS BY DISTRICT

	Total	Prison	Probation	Jail/Fine	Prison	Probation	Jail
STATE TOTALS	22,119	6,827	11,645	3,647	30.9	52.6	16.5
DISTRICT I - TOTALS	6,556	1,802	3,809	945	27.5	58.1	14.4
02 Recorder's Court	5,024	1,395	2,858	771	27.8	56.9	15.3
82 Wayne County	1,532	407	951	174	26.6	62.1	11.4
DISTRICT II - TOTALS	7,193	2,547	3,386	260	35.4	47.1	17.5
06 Oakland	2,377	899	1,021	457	37.8	43.0	19.2
07 Genesee	907	472	403	32	52.0	44.4	3.5
10 Saginaw	729	175	234	320	24.0	32.1	43.9
16 Macomb	683	244	304	135	35.7	44.5	19.8
18 Bay	334	116	218	-	34.7	65.3	-
21 Isabella	95	16	67	12	16.8	70.5	12.6
22 Washtenaw	698	310	322	66	44.4	46.1	9.5
24 Sanilac	30	7	15	8	23.3	50.0	26.7
31 St. Clair	240	53	153	34	22.1	63.8	14.2
35 Shiawassee	50	13	22	15	26.0	44.0	30.0
38 Monroe	252	71	177	4	28.2	70.2	1.6
39 Lenawee	217	61	73	83	28.1	33.6	38.2
40 Lapeer	132	23	75	34	17.4	56.8	25.8
42 Midland	109	12	88	9	11.0	80.7	8.3
44 Livingston	140	35	85	20	25.0	60.7	14.3
52 Huron	33	6	16	11	18.2	48.5	33.3
54 Tuscola	70	17	40	13	24.3	57.1	18.6
55 Clare, Gladwin	97	17	73	7	17.5	75.3	7.2
DISTRICT III - TOTALS	8,370	2,478	4,450	1,442	29.6	53.2	17.2
01 Hillsdale	56	22	32	2	39.3	57.1	3.6
02 Berrien	457	156	267	34	34.1	58.4	7.4
04 Jackson	735	340	323	72	46.3	43.9	9.8
05 Barry, Eaton	265	97	139	29	36.6	52.5	10.9
08 Ionia, Montcalm	161	72	72	17	44.7	44.7	10.6
09 Kalamazoo	664	179	416	69	27.0	62.7	10.4
11 Alger, Luce, Schoolcraft	75	19	50	6	25.3	66.7	8.0
12 Baraga, Houghton, Keweenaw	37	7	27	3	18.9	73.0	8.1
13 Antrim, Grand Traverse, Leelanau	148	51	73	24	34.5	49.3	16.2
14 Muskegon	569	217	330	22	38.1	58.0	3.9
15 Branch	109	35	62	12	32.1	56.9	11.0
17 Kent	1,854	530	787	537	28.6	42.4	29.0
19 Benzie, Manistee	68	11	45	12	16.2	66.2	17.6
20 Ottawa	257	42	200	15	16.3	77.8	5.8
23 Iosco, Oscoda	37	6	25	6	16.2	67.6	16.2
25 Marquette	75	28	38	9	37.3	50.7	12.0
26 Alpena, Alma, Montmorency, Presque Isle	113	16	83	14	14.2	73.5	12.4
27 Newago, Oceana	161	40	40	81	24.8	24.8	50.3
28 Missaukee, Wexford	65	20	33	12	30.8	50.8	18.5
29 Clinton, Gratiot	174	53	108	13	30.5	62.1	7.5
30 Ingham	645	141	319	185	21.9	49.5	28.7
32 Gogebic, Ontonagon	33	6	27	-	18.2	81.8	-
33 Emmet, Charlevoix	94	14	75	5	14.9	79.8	5.3
34 Roscommon, Arenac, Ogemaw	68	18	35	15	26.5	51.5	22.1
36 Van Buren	130	39	27	64	30.0	20.8	49.2
37 Calhoun	341	90	204	47	26.4	59.8	13.8
41 Dickenson, Iron, Menominee	117	17	82	18	14.5	70.1	15.4
43 Cass	78	18	51	9	23.1	65.4	11.5
45 St. Joseph	162	44	71	47	27.2	43.8	29.0
46 Otsego, Kalkaska, Crawford	114	35	73	6	30.7	64.0	5.3
47 Delta	41	23	16	2	56.1	39.0	4.9
48 Allegan	130	27	80	23	20.8	61.5	17.7
49 Mecosta, Osceola	152	26	113	13	17.1	74.3	8.6
50 Mackinac, Chippewa	53	12	33	8	22.5	62.3	15.1
51 Lake, Mason	87	20	60	7	23.0	69.0	8.0
53 Cheboygan	45	7	34	4	15.6	75.6	8.9

1984 COURT DISPOSITIONS BY GROUPS

A1a

GROUP A --- No prior prison term, juvenile probation only or one jail term

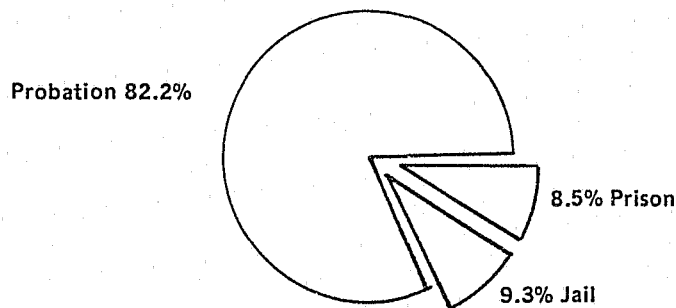

A1b

GROUP B --- Juvenile record, multiple jail terms or one term of adult probation

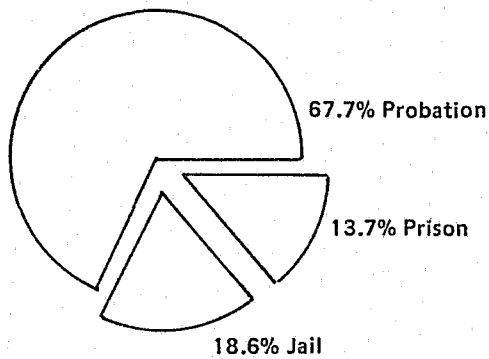

A1c

GROUP C --- Multiple probation terms, probation violators or violators or prior prison terms

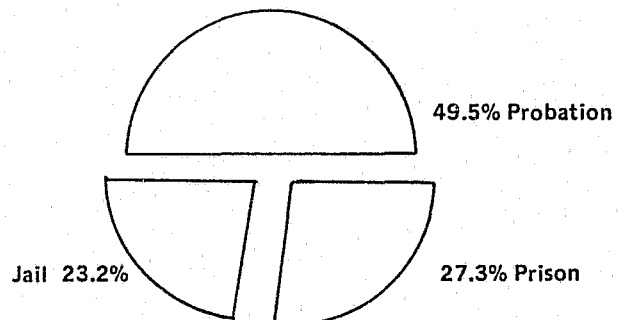

1984 Court Dispositions by Groups -- Continued

A1d GROUP D — Institutional prisoners, escapees, parole violators with new sentence

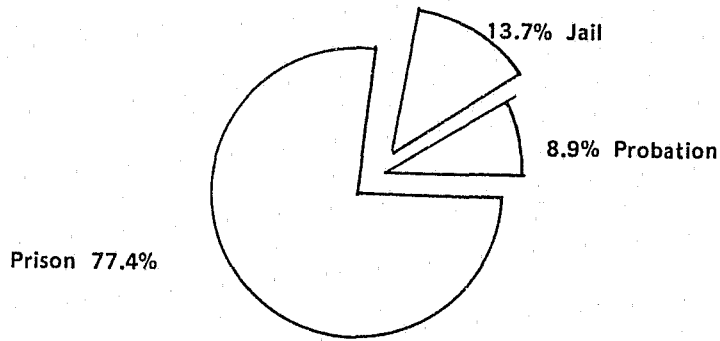

A1e Group breakdown as percent of all court dispositions

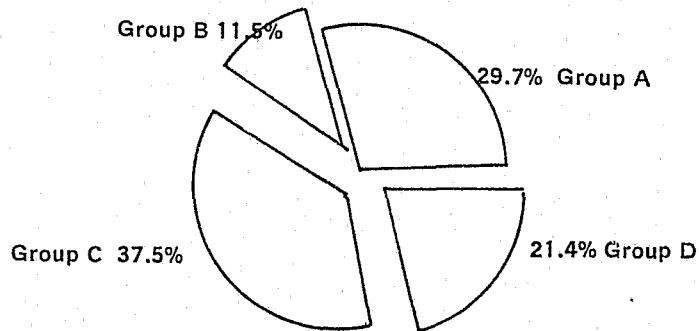

A2 COURT DISPOSITIONS BY TYPE FOR 1984

Compiled Laws	Offense	Maximum	Total Cases	Prison	Probation	Jail	Other
TOTAL COUNTS	VIOLATIONS ATTEMPTS		20309 6571	7194 911	8616 3929	2519 1409	1980 322
750.360	Larceny From Building	04	1944	556	735	426	227
	ATTEMPTS		1209	144	651	345	69
750.110	Break & Enter	10	1530	512	644	173	201
	ATTEMPTS		784	170	414	142	58
750.110	Break & Enter Occupied Dwelling	15	1467	548	557	160	202
	ATTEMPTS		51	15	27	8	1
750.535	Receiving Stolen Property	05	956	281	405	172	98
	ATTEMPTS		429	52	264	106	7
750.227	Carrying Concealed Weapons	05	715	99	365	146	105
	ATTEMPTS		600	44	445	95	16
333.7401	Unlawful Man. Del. Poss Sched 4 Subst	04	694	76	465	88	65
	ATTEMPTS		273	2	203	57	11
750.82	Felonious Assault	04	720	220	367	83	50
	ATTEMPTS		151	7	86	47	11
750.82	Robbery Armed	L	820	770	20	12	18
	ATTEMPTS		30	18	9	2	1
333.7403	Poss. Contr Danger Sub Under 50 Grams	04	673	83	466	97	27
	ATTEMPTS		166	12	123	27	4
750.356	Larceny Over \$100	05	566	161	234	65	106
	ATTEMPTS		272	34	151	69	18
750.356A	Larceny from Motor Vehicle or Trailer	05	505	100	235	67	103
	ATTEMPTS		318	32	175	83	28
750.413	Unlawfully Drving Away an Automobile	05	556	182	205	92	77
	ATTEMPTS		247	56	118	61	12
750.249	Uttering & Publishing	14	466	169	186	50	61
	ATTEMPTS		259	62	142	44	11
333.7401	Unlawful Man Del Poss 50 - 225 Grams	20	491	196	231	40	24
	ATTEMPTS		196	41	103	47	5
400.60	False State - Obtain Relief over \$500	04	466	4	430	14	18
	ATTEMPTS		103		97	3	3
750.414	Unlawful Use Auto W/O Intent to Steal	02	401	32	252	96	21
	ATTEMPTS		41		27	13	1
750.357	Larceny From Person	10	309	126	129	36	18
	ATTEMPTS		127	28	63	30	6
750.111	Entering W/O Breaking	05	365	77	194	67	27
	ATTEMPTS		62	11	38	10	3
750.520C	Criminal Sexual Conduct, 2nd Degree	15	328	167	132	12	17
	ATTEMPTS		97	29	57	7	4
750.193	Brk, Escp Or Attp to Break, Escp Pri	05	364	344	2	18	
	ATTEMPTS		20	18		2	
333.7401	Unlawful Man Del Poss Sched 1,2,3 Sub	07	293	69	163	30	31
	ATTEMPTS		79	9	54	12	4
750.520B	Criminal Sexual Conduct, 1st Degree	L	343	322	10	3	8
	ATTEMPTS		20	10	8	2	
750.530	Robbery, Unarmed	15	312	172	93	19	28
	ATTEMPTS		21	4	13	2	2
750.520E	Criminal Sexual Conduct, 4th Degree	02	296	27	213	44	12
	ATTEMPTS		20		13	6	1
750.479	Resisting, Obstructing Officer	02	272	29	138	81	24
	ATTEMPTS		41		27	13	1
750.377A	Malicious Destruction Personal Prop	04	190	26	93	24	47
	ATTEMPTS		89	2	66	15	6
750.520D	Criminal Sexual Conduct, 3rd Degree	15	223	172	25	15	11
	ATTEMPTS		40	17	18	5	
750.131A	Checks W/O Account or W/O Suff Funds	02	241	30	140	51	20
	ATTEMPTS		22		20	2	
750.84	Asslt W/Int Gr Bod Hzm Less Murder	10	244	150	67	13	14
	ATTEMPTS		5	3	2		

750.218	False Pretenses W/Int to Defraud ATTEMPTS	10	114 113	26 16	58 68	12 17	18 12
257.625	Drive M.V. Addict or Intox 3rd Off. ATTEMPTS	04	203 1	33	90	44 1	36
750.174	Embz-Agt, Serv, Emp, Trust Over \$100 ATTEMPTS	10	144 54	12 5	98 42	8 6	26 1
750.321	Manslaughter ATTEMPTS	15	186 5	133 2	47 3	4	2
750.317	Second Degree Murder ATTEMPTS	L	189	187	1		1
333.7403	Poss Cont Danger Sub in Sched 1,2,3,4 ATTEMPTS	02	138 22	14	91 17	25 5	8
750.248	Forgery of Records, Other Instruments ATTEMPTS	14	119 36	27 5	61 20	12 8	19 3
750.380	Malicious Dest. of Bldg. Over \$100 ATTEMPTS	04	99 45	10 2	53 34	16 7	20 2
750.89	Asslt/W/Intent to Rob & Steal Armed ATTEMPTS	L	133 2	92 1	31	4	6 1
750.224	Mfg or Possession of Illegal Weapons ATTEMPTS	05	80 35	20 2	39 25	11 8	10
750.520G	Asslt W/Int C Sex C 1st Degree ATTEMPTS	10	109 5	58 1	41 3	6 1	4
750.324	Negligent Homicide ATTEMPTS	02	107 4	6	82 4	7	12
750.83	Asslt W/Intent to Commit Murder ATTEMPTS	L	100	95	2	1	2
750.520G	Asslt W/Intent C Sex C 2nd Degree ATTEMPTS	05	89 6	19 1	64 4	4	2 1
750.362	Larceny by Conversion over \$100 ATTEMPTS	05	72 22	18 6	38 9	7 5	9 2
750.316	First Degree Murder ATTEMPTS	L	86	86			
750.175Q	Sale/Use or Cards Unlawful Obtained ATTEMPTS	04	48 36	15 3	24 24	2 7	7 2
750.77	Preparing to Burn - Value over \$50 ATTEMPTS	04	53 24	3 2	38 18	8 4	4
750.72	Burning Dwelling House ATTEMPTS	20	54 22	33 10	15 10	2 2	4
333.7407	Distribution W/O License ATTEMPTS	04	34 42	5 4	18 27	3 7	8 4
750.157N	Theft of Credit Cards ATTEMPTS	04	58 18	17 1	19 14	6 2	16 1
750.377B	Mal Dest Police or Fire Dept Prop ATTEMPTS	04	60 15	14	22 8	15 6	9 1
769.11	Habitual Criminal, 3rd Felony ATTEMPTS	L	70	64	3	3	
750.73	Burning Other Real Property ATTEMPTS	10	49 17	16 5	26 11	5 1	2
769.12	Fourth Felon Offender ATTEMPTS	L	62	55	1	4	2
750.531	Bank Safe & Vault Robbery ATTEMPTS	L	50 7	36 5	9 1	2 1	3
750.136	Cruelty to Children ATTEMPTS	04	40 17	7	26 11	4 5	3 1
750.74	Burning Personal Property ATTEMPTS	04	32 23	2 1	26 16	4 5	1
750.157P	Intent to Sell or Use Credit Cards ATTEMPTS	04	27 21	7 3	11 14	3 4	6
750.197C	Jail Brking W/Viol or Danger Weapon ATTEMPTS	04	47 1	45	1	2	
750.157A	Conspiracy ATTEMPTS	L	47	15	25	7	
752.811	Break & Enter Coin Operated Devices ATTEMPTS	03	27 19	5 1	12 15	3 2	7 1
752.861	Careless Use of Firearms to Kill ATTEMPTS	02	46	7	36	3	

750.349	Kidnaping	L	43	38	2		3
	ATTEMPTS		1				1
752.191	Felonious Driving	02	36	5	23	3	5
	ATTEMPTS		8		6	2	
750.505	Common Law Off, No Express Penalty	05	30	9	13	5	3
	ATTEMPTS		10		3	7	
800.283	Weapons, Prohibit Furnish in Prison	05	39	38		1	
	ATTEMPTS						
750.199A	Absconding or Forfeiting Bond	04	31	18	4	9	
	ATTEMPTS		4	1	3		
750.253	Uttering Counterfeit Notes	05	19	7	9	1	2
	ATTEMPTS		15	5	10		
769.10	Habitual Criminal, 2nd Felony	L	33	31		2	
	ATTEMPTS						
750.88	Asslt W/Intent to Rob & Steal Unarmed	15	32	19	12	1	
	ATTEMPTS						
750.226	Carry Weapon W/Unlawful Intent	05	22	9	8	5	
	ATTEMPTS		10		5	5	
800.281	Transport Contraband into Prison	05	29	12	10	4	3
	ATTEMPTS		2			2	
257.617	Leave Scene Personal Injury Accident	05	30	3	22	4	1
	ATTEMPTS						
333.7401	Unlawful Man Del Poss Sched 5 Subst	02	16	2	6	5	3
	ATTEMPTS		14	1	9	4	
750.377	Malicious Destruction of Animals	04	18	3	10	2	3
	ATTEMPTS		11	1	7	1	2
750.227B	Poss of Firearm During Comm of Fel	10	25	22	1	1	1
	ATTEMPTS		1		1		
257.257	Alter Regis Plates Poss Forged Reg	05	18	5	7	3	3
	ATTEMPTS		7		3	4	
750.213	Extortion	20	19	11	7	1	
	ATTEMPTS		5	1	2	1	1
333.7403	Poss of Contr Danger Sub 50-225 gram	20	18	3	15		
	ATTEMPTS		4		3	1	
750.362A	Larceny of Rented MV/Trlr Ovir \$100	02	12	1	6	3	2
	ATTEMPTS		9		6	3	
750.116	Possession of Burglars Tool	10	17	10	3	3	1
	ATTEMPTS		2		2		
750.92	Att Commit Crime W/Penalties Under 5	02	16		4	1	11
	ATTEMPTS		1		1		
333.7404	Use Contr Danger Sub in Sched 1,2,3,4	01	9		5	2	2
	ATTEMPTS		7		3	3	1
750.423	Perjury - Wilfully Swear Falsely	15	15		10	2	3
	ATTEMPTS						
750.251	Forgery of Bank Bills & Notes	07	11	1	5	1	4
	ATTEMPTS		4	1	1	2	
750.117	Bribery of Public Officer	04	7	1	5	1	
	ATTEMPTS		8		6	2	
750.479A	Driver Assault Police	02	14	3	9		2
	ATTEMPTS		1			1	
257.254	Possession Stolen Auto	10	12	4	7	1	
	ATTEMPTS		2	1	1		
750.211A	Explosive Device, Constr. Poss & Use	04	10	1	6	1	2
	ATTEMPTS		3		1	2	
750.520	Rape	L	6	3	2	1	
	ATTEMPTS		5		5		
750.87	Asslt W/Intent to Commit Felony	10	11	7	3		1
	ATTEMPTS						
570.152	Violation of Building Trust Act	03	8	3	4	1	
	ATTEMPTS		2		2		
750.451	Accosting & Soliciting 3rd Offense	02	10	3	4	1	2
	ATTEMPTS						
750.422	Perjury	15	4	3	1		
	ATTEMPTS		5	1	3	1	
750.75	Burning Insured Property	10	8	2	5	1	
	ATTEMPTS		1		1		

750.338	Gross Indecency between Males ATTEMPTS	05	8 1	1	5 1	2	
750.357A	Larceny Livestock ATTEMPTS	04	5 4	1 1	3 3		1
333.7401	Unlawful Man Del Poss of Cont Sub ATTEMPTS	L	8	7	1		
333.7405	Prescription Violation ATTEMPTS	02	3 5		1 3	2 2	
750.175	Embz-Public Officer Agent Servant ATTEMPTS	10	6 1		3 1	1	2
333.7402	Counterfeit of Contr Sub in Sched 4 ATTEMPTS	04	5 2		5 2		
750.131	Che W/O Suff Funds Under \$50-3rd Off ATTEMPTS	01	6 1		5 1		1
257.903	Perjury In Vio Motor Vehicle Code ATTEMPTS	15	4 2		3 2	1	
205.509	Poss & Trans Untaxed Cigarettes ATTEMPTS	05	5 1	1	4 1		
750.210	Possession of Bomb ATTEMPTS	05	2 4	1	1 4		
750.490	Unlawful Use of Public Funds ATTEMPTS	02	6		4	1	1
750.206	Place Explosive W/Int to do Damage ATTEMPTS	25	2 3	2	2	1	
750.165	Refusing to Support Wife or Children ATTEMPTS	04	5		2	1	2
750.282	Fraud Use of Connect of Pub Util Serv ATTEMPTS	04	3 2		2 2		1
750.303	Keep Gaming Room for Hire, Gain ATTEMPTS	02	5		1	2	2
750.92	Att Commit Crime W/Penalties 5-Life ATTEMPTS	05	2 2		2 2		
800.285	Transport Drugs into Prison ATTEMPTS	05	4	3	1		
750.211	Conspiracy to Possess Explosives ATTEMPTS	05	4	1	1	1	1
750.363	Larceny by False Personation ATTEMPTS	05	1 3	1	2		1
750.161	Desertion & Non Support ATTEMPTS	03	4		4		
750.455	Pandering ATTEMPTS	20	3		3		
750.205	Place Explosive by Prop W/Int Disch ATTEMPTS	15	3	3			
333.7402	Counterfeit of Controlled Sub ATTEMPTS	10	2 1	1	1	1	
750.254	Possession of Forged Notes ATTEMPTS	05	3	2	1		
750.338B	Gross Indecency between Male & Female ATTEMPTS	05	2 1		2 1		
750.425	Incite or Procure to Commit Perjury ATTEMPTS	05	3	1	2		
750.177	Conceal Mortgaged Prop over \$100 ATTEMPTS	02	3	1	2		
750.91	Attempt to Murder ATTEMPTS	L	1 1	1 1			
750.329	Death, Firearm without Malice ATTEMPTS	15	2	1		1	
750.86	Asslt W/Intent to Main ATTEMPTS	10	2	2			
750.136A	Torture by Parent or Guardian ATTEMPTS	10	2	1	1		
750.176	Embz-Administrator, Exucutor Guardian ATTEMPTS	10	2		1		1
750.367	Larceny of Tree, Shrubbery ATTEMPTS	05	2			2	

750.383A	Malicious Dest Machinery/Equip/Tools ATTEMPTS	04	1	1			
750.439	Polygamy ATTEMPTS	04	2		1	1	
451.809	Violate Security Act ATTEMPTS	03	1		1		
750.491	Mutilating, Removing Public Records ATTEMPTS	02	1		1	1	
333.7402	Counterfeit of Contr Sub in Sched 5 ATTEMPTS	02	2		2		
750.325	Manslaughter Due to Oper of Mot Veh ATTEMPTS	02	2		2		
752.862	Careless Use of Firearms to Injure ATTEMPTS	01	2		2		
750.25	Adulteration of Butter, Cream ATTEMPTS	01	2		1	1	
750.356B	B & E Coin Operated Telephone ATTEMPTS	01	2			1	1
750.115	Entering Without Permission ATTEMPTS	00	2		2		
750.448	Accosting, Soliciting for Immoral Act ATTEMPTS	00	2			1	1
750.207	Use Explosives With Intent Dest/Inj ATTEMPTS	L	1	1			
750.350	Enticing Away Child Under 14 Yrs ATTEMPTS	L	1		1		
750.457	Accept Earnings of Prostitute ATTEMPTS	20	1	1			
750.459	Transporting Female for Prostitution ATTEMPTS	20	1	1			
750.259	Affixing Fictitious Signature ATTEMPTS	14	1		1		
752.541	Riot ATTEMPTS	10	1				1
750.181	Embezzled Prop Belong To Self & Other ATTEMPTS	10	1	1			
750.280	Gross Frauds & Cheats at Common Law ATTEMPTS	10	1		1		
750.183	Aid Escape of & Rescue Prisoners ATTEMPTS	07	1			1	
752.802	Mfg Slugs for Vending Machines ATTEMPTS	05	1			1	
259.183	Unlawful Use of Aircraft ATTEMPTS	05	1		1		
750.452	Keeping House of Ill Fame ATTEMPTS	05	1			1	
750.119	Bribery of Jurors, Appraisers ATTEMPTS	04	1			1	
750.157R	Forg/Alter/Counterfeiting Cr Cards ATTEMPTS	04	1				1
750.279	Fraudulent Disposition Personal Prop ATTEMPTS	04	1			1	
750.417	Rem Auto Outstate W/O Cons of Mtgee ATTEMPTS	04	1		1		
750.540	Cut, Break. Tap Wire or Cable ATTEMPTS	02	1		1		
752.881	Reckless Use of Bow & Arrow ATTEMPTS	02	1		1		
750.167	Drunk and Disorderly, 3rd ATTEMPTS	02	1		1		
750.230	Pistols, Alteration of ATTEMPTS	02	1		1		
750.81A	Assault & Inflict Serious Injury ATTEMPTS	01	1		1		
750.197	Break Esc Jail or Att Prior to Trial ATTEMPTS	01	1			1	

750.226A	Pocket Knife Opened by Mech Device ATTEMPTS	01	1		1		
750.234	Disch Firearm Int Aim W/O Malice ATTEMPTS	01	1		1		
750.305	Publication, Distr of Betting Odds ATTEMPTS	01	1			1	
750.387	Malicious Dest Tombs & Memorials ATTEMPTS	01	1		1		
750.228	Safety Inspection of Firearms ATTEMPTS	00	1		1		
750.337	Use Ind Lang Presence of a Female ATTEMPTS	00	1		1		
750.383	Malicious Dest. Boundary Markers Etc. ATTEMPTS	00	1				1
750.390	Malicious Annoyance by Writing ATTEMPTS	00	1		1		

A3 Court Disposition: 5 Year Comparison

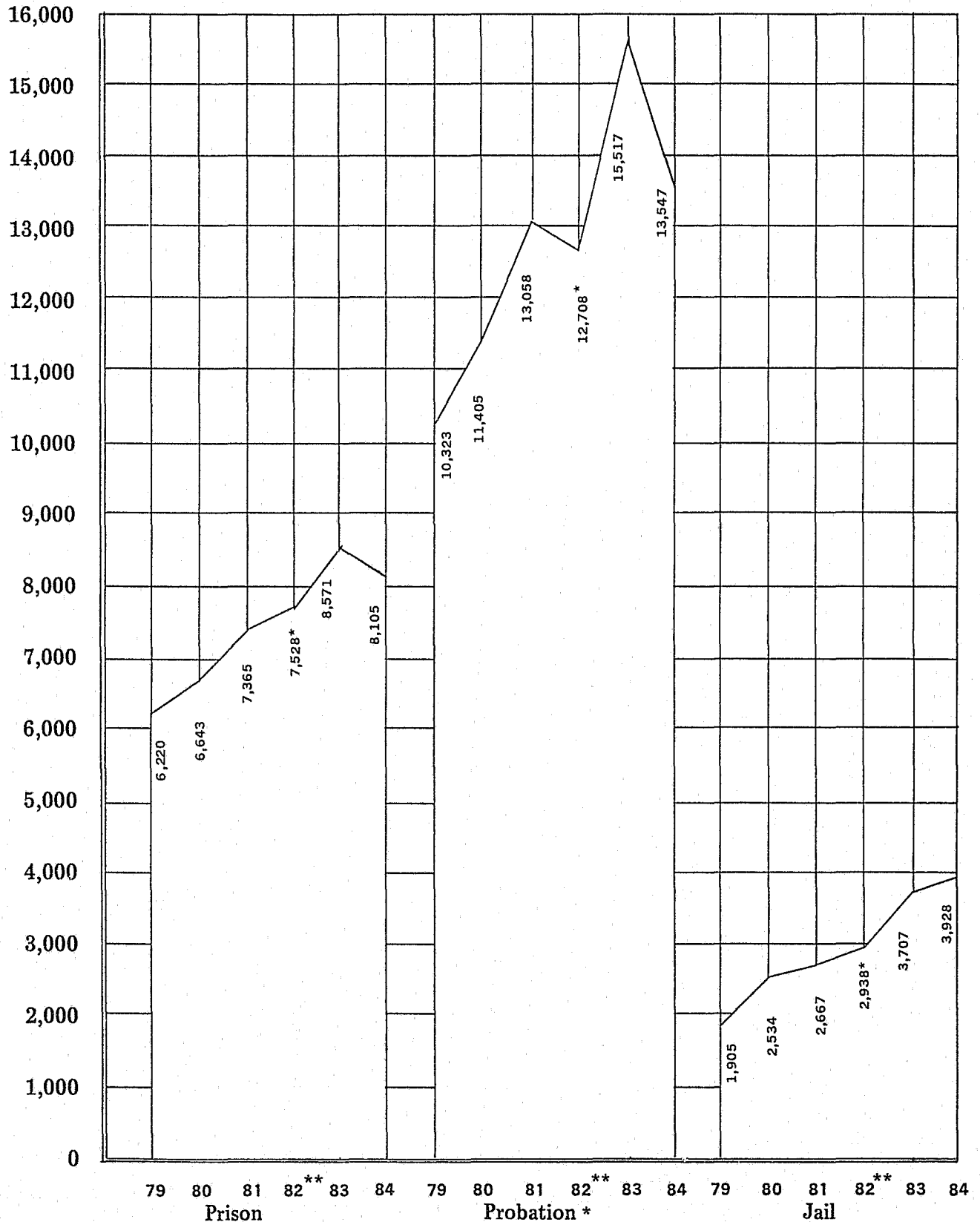

NOTE: Each conviction is counted; some persons will have multiple convictions

* Includes HYTA Convictions

** Figure corrected from 1981 report

PRISON COMMITMENTS

The B tables represent people to the fullest extent possible. They count the number of prison commitments for the year, reporting the longest sentence from each commitment. A person may, however, be committed more than once in a year with multiple sentences per commitment. In such cases that person would be counted each time s/he was committed. In 1984 there were commitments totaling 6,142 for non-attempts and 1,010 for attempts. In addition to listing the number of commitments by crime, the charts give the minimum sentences for each crime. Those minimum sentences falling between the various categories are grouped with the higher number. The B-2 tables contain men and women commitments but B-3 lists only female commitments. The charts also contain an average minimum sentence for the various crimes.

The B/a table "Reported Crimes Versus Commitments in Michigan" compares the annual reported index crimes (in hundreds of thousands) with the annual prison commitments. The 1984 figures were not available from the Michigan State Police at the time of this printing.

Other charts cover commitments by age, race, sex and crime types. The last chart illustrates the percentage change in crimes against people as percent of total commitments.

+ + +

B1

Commitments and Prison Population through Dec. 31, 1984
Compared with State Census Populations

THOUSANDS MICHIGAN PRISONERS AND ANNUAL COMMITMENTS
1916 - 1984

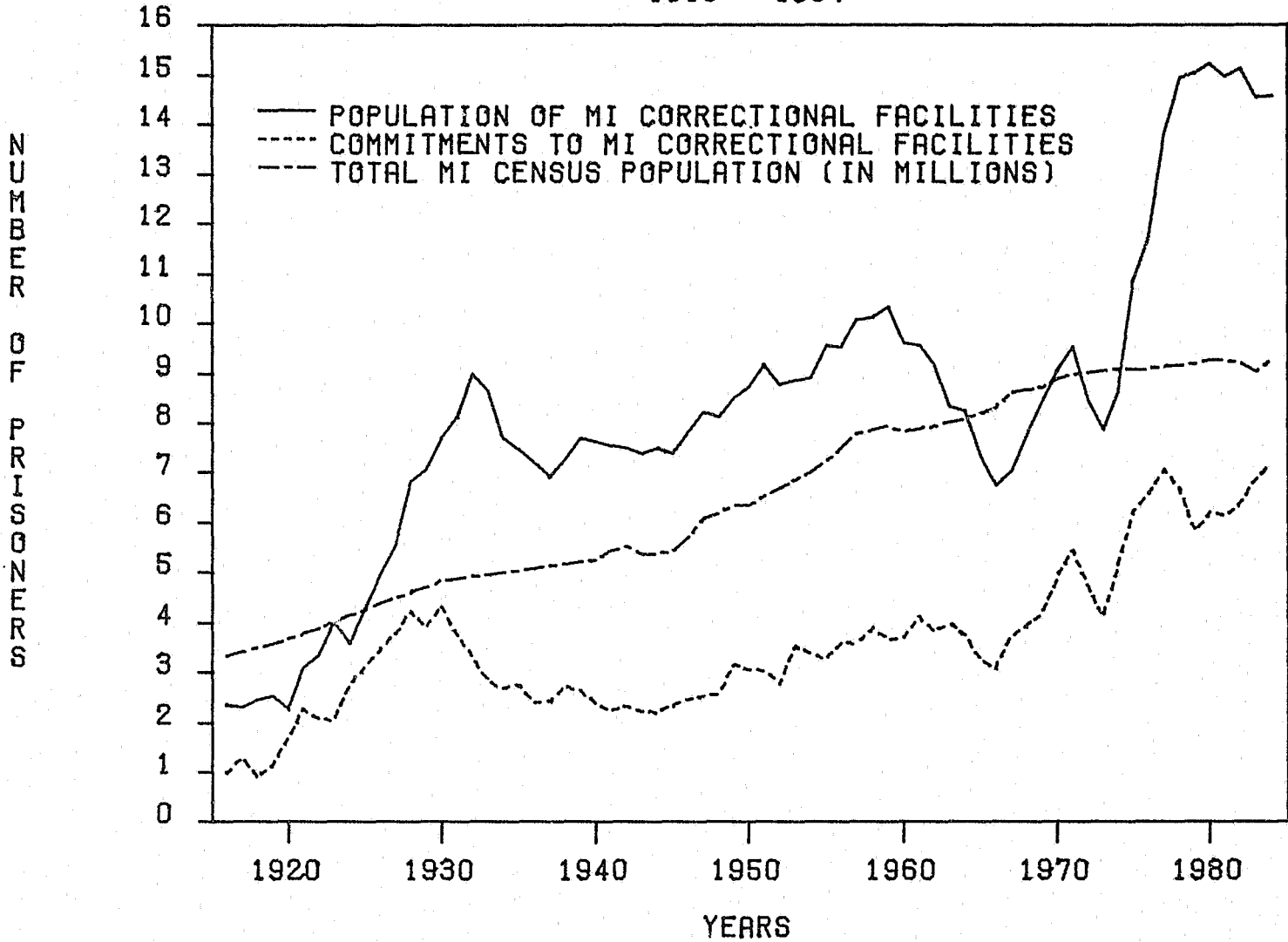

B1a Reported Crimes Versus Commitments in Michigan 1974 - 1983

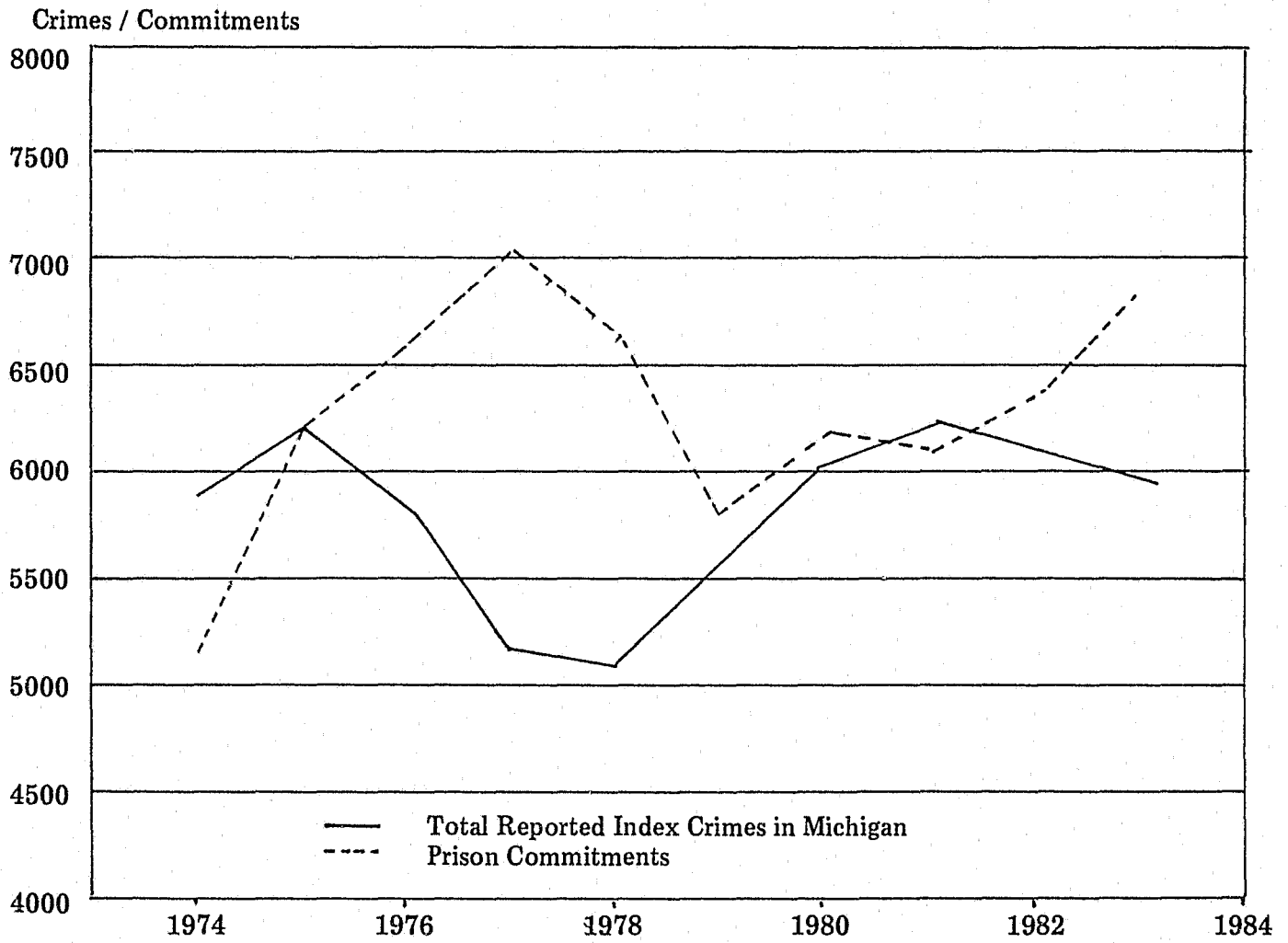

		GRAND TOTAL	.5	1	1.5	2	2.5	3	3.5	4	4.5	5	10	15	20	25	>25	LIFE	AVG
750.157P Intent To Sell or Use Credit Card	04	4		1	1	2													1.6
		2		2															1.0
750.77 Prepare To Burn Property Over \$50	04	6				4	2												2.0
		2			2														1.3
750.157N Theft of Credit Cards	04	11	4	3	1	2		1											1.0
		2			2														1.5
750.74 Burning of Personal Property	04	6	3	3															0.5
		2	1	1															0.5
750.377B Malicious Dest Police Property	04	9		1		2	2	1		2	1								2.7
		1			1														1.3
750.377A Mal. Dest Property Over \$100	04	19		1	6	5	2	4		1									2.1
		1			1														1.3
752.811 Enter Vending Machine	03	4		1	2	1													1.5
		1		1															1.0
750.520E Criminal Sexual Conduct, 4th Degree	02	18	1	6	11														1.1
		4	2	2															0.6
750.479A Mtr. Veh. Opr. Asslt. Police Ofcr	02	3	2	1															0.3
750.479 Resisting or Obstructing Officer	02	16		1	11	1	1	2											1.5
		3	2		1														0.4
333.7402 Counterfeit of Sub in Sched 5	02	6	3		1	1									1				3.9
		2		1		1													1.5
750.131A Checks W/O Acct. or Suff. Funds	02	12	1	1	18			1				1							1.6
		1			1														1.3
750.451 Accosting & Soliciting 3rd Offens	02	4	2		1	1													0.8
		1			1														1.2
750.197A Break or Escape Fm Custody	01	4	1	3															0.6
335.341 Violation of Drug Law	01	3	2					1											1.0
		1							1										3.0
333.7404 Use of Controlled Dangerous Substance	01	4	4																0.5
		1				1													2.0
769.10 Habitual Criminal, Second Felony	LIFE	10	7		1	1				1									0.7
769.12 Habitual Criminal, Fourth Felony	LIFE	7	1			2		1		2			1						3.1
769.11 Habitual Criminal, Third Felony	LIFE	3			1			1		1									2.7
750.157B Incite, Induce to Commit Crime	LIFE	3	1	1		1													1.0
750.91 Attempt to Commit Murder	LIFE	2						1										1	3.0
750.213 Extortion	20	12	3	1		1		1	2				4						4.0
750.459 Transport Female for Prostitution	20	1									1								4.5
750.88 Assault to Rob, Unarmed	15	17	1	1	3	1		6				2	3						3.3
750.329 Firearm, Cause Death W/O Malice	15	2					1						1						5.2

		GRAND TOTAL	.5	1	1.5	2	2.5	3	3.5	4	4.5	5	10	15	20	25	>25	LIFE	AVG
750.422	Perjury	15	2									2							4.9
750.423	Perjury - Will Swear Falsely	15	1	1															1.0
750.227B	Poss. of Firearm Comm. of Felony	10	34			34													2.0
750.116	Poss. of Burglar Tools	10	6	1	2		2	1					1						2.1
750.87	Asslt to Commit Felony	10	5			1		1				1	2						4.4
750.75	Burning Insured Property	10	3									3							5.0
750.181	Emb. Prop. of Self & Other Person	10	1					1											3.0
800.283	Weapons, Prohibit Furnish in Prison	05	38	4	6	6	9	4	6		1	1		1					2.0
750.362	Larceny by Conversion 0/100	05	12	1	2		5	1	1	1					1				3.0
800.285	Transport Drugs into Prison	05	10	10															0.5
750.226	Carry Weapon W/Unlawful Intent	05	9	3			2	1	2	1									1.7
257.902	Drunk Driving While on Probation	05	4		1			2	1										2.2
750.363	Larceny by False Personation	05	2	1				1											1.2
257.617	Leaving Scene of P.I. Accident	05	1			1													1.2
257.625	Drunk Driving - 3rd Offense	04	26		4	7	5	4	3	3									2.0
750.199A	Absconding or Forfeiting Bond	04	10	1			1	3	4	1									2.4
750.136	Cruelty to Children	04	6		1	1		1	1	1				1					2.7
400.60	False State - Obtn. Relief \$500	04	4	1	1		2												1.3
750.211A	Explosive Device - Construction	04	4	3		1													0.3
570.152	Viol of Bldg Trust Act	03	2			1			1										2.2
750.414	UDAA W/O Intent to Steal	02	17	2	2	11		1	1										1.2
750.324	Negligent Homicide	02	9	3	2	4													0.7
752.861	Careless Use of Firearms	02	5	1	1	2	1												1.0
752.191	Felonious Driving	02	5	2		3													0.7
750.131	Checks No Funds	02	4	2		1		1											0.9

		GRAND TOTAL	.5	1	1.5	2	2.5	3	3.5	4	4.5	5	10	15	20	25	>25	LIFE	AVG
750.177	Conceal Mortgaged Property 0/\$100	02	2	1	1														0.6
750.362A	Larceny of Rent Mtr. V/Tlr 0/\$100	02	1	1															0.5
750.195	Break, Esc Jail or Att While Serv	01	25	25															0.5
750.335A	Indecent Exposure	01	5	4		1													0.4
205.509	Poss & Trans Untaxed Cigarettes	01	3	1				2											2.0
750.254	Poss Forged Notes	01	3	1	2														1.0
333.7413	VDL - 2nd or Subsqnt Off.	01	2	1	1														0.5
750.205	Place Explosive by Prop. W/I Disch	01	2		1	1													1.7
750.206	Place Explosive W/I to do Damage	01	1													1			25.0
750.81A	Asslt and Inflict Serious Injury	01	1	1															1.0
750.250	Forgery of Notes, Etc.	01	1										1						7.0
750.197	Break Esc Jail or Att Prior to Trial	01	1		1														1.5
750.457	Accept Earnings of Prostitute	01	1										1						6.5
333.7410	Distrib to Minors	01	1		1														1.5
750.448	Accosting, Soliciting for Immoral 3 mo/\$100		1			1													2.0
750.115	Entering W/O Permission 3 mo/\$100		1		1														1.3

B3

FEMALE COMMITMENTS & MINIMUM TERM DISTRIBUTION

	VIOLATIONS ATTEMPTS Max. Pen.	GRAND																LIFE	AVG
		TOTAL	.5	1	1.5	2	2.5	3	3.5	4	4.5	5	10	15	20	25	>25		
GRAND TOTAL - 544		428	23	62	81	88	23	48	5	21	5	23	30	5	4	1	1	8	2.9
		116	7	28	42	15	4	14	2	3					1				1.7
333.7403 Poss of Contr Danger Sub 650 Gran	LIFE	12	1	4	2	2	2								1				3.0
		4		3	1														1.0
333.7401 Unlawful Man, Del, Poss of Cont Sub	LIFE	22	2	4	6	4		1	2			1	1		1				3.0
		3		1	1	1													1.4
750.317 Murder, Second Degree	LIFE	22		1		1				1	1	3	7	4	2	1		1	9.0
		1												1					20.0
750.529 Robbery, Armed	LIFE	17		2	2	4	1	2				3	3						3.3
		1	1																0.5
750.72 Burning a Dwelling House	20	1												1					13.0
		1						1											3.0
750.5200 Criminal Sexual Conduct, 3rd Degr	15	1						1											3.0
		1			1														1.1
750.249 Uttering & Publishing	14	34		8	2	4	1	6		4	2	4	3						3.0
		15		1	4	3	2	3	2										2.2
750.357 Larceny from a Person	10	7				4	1		1	1									2.5
		4			1	1	2												2.1
750.110 Break & Enter Occ. Dwelling	10	3	1		1														1.5
		3		2	1														1.1
750.218 False Pretense to Defraud	10	2		1						1									2.5
		2			1	1													1.7
750.84 Assault Less than Murder	10	8	2	2	1	1		1					1						2.0
		1						1											3.0
750.356 Larceny over \$100	05	24		2	6	4	3	4	1	2		2							2.4
		4		1	2	1													1.4
750.253 Uttering Counterfeit Notes	05	3		2	1														1.1
750.227 Carrying Concealed Weapons	05	5		1	1			1		2									2.6
		2		1	1														1.0
750.316 Murder, 1st Degree	LIFE	6																6	LIFE
750.193 Escape from Prison	05	21	7	3	7	2	1			1									1.2
		2	2																0.3
800.281 Transport Contraband into Prison	05	1		1															1.0
750.505 Common Law Off. no Expr Penalty	05	1						1											3.0
750.360 Larceny from a Building	04	129	3	25	32	30	9	20		5		3	2						2.0
		53	3	10	21	8		8		3									1.6
750.82 Felonious Assault	04	6			3	2		1											1.8
		2			2														1.3
750.157P Intent to Sell or Use Credit Card	04	2				2													2.0
		2		2															1.0
750.157N Theft of Credit Cards	04	1				1													2.0
		2			2														1.5

24

		GRAND TOTAL	.5	1	1.5	2	2.5	3	3.5	4	4.5	5	10	15	20	25	>25	LIFE	AVG
333.7407	Distribution Without a License	04	1		1														1.5
			1		1														1.3
750.77	Prepare to Burn Property Over \$50	04	1			1													2.0
			1		1														1.3
750.157Q	Sale/Use Cr. Cards Unlawfully Obt.	04	6	3	1	2													1.4
			1	1															0.5
750.451	Accosting & Soliciting 3rd Offens	02	2		1	1													1.6
			1		1														1.2
333.7402	Counterfeit of Sub in Sched 5	02	1	1															1.0
750.197A	Break or Escape from Custody	01	3	3															0.8
750.89	Asslt to Rob, Armed	LIFE	5		2			1					2						4.5
750.83	Asslt W/I to Commit Murder	LIFE	4										3				1		14.8
769.12	Habitual Criminal, 4th Fel	LIFE	3	1		2													1.3
750.349	Kidnapping	LIFE	3			1	1											1	2.2
750.520B	Crim Sex Cond, 1st Degree	LIFE	2	1									1						5.0
769.11	Habitual Criminal, 3rd Felony	LIFE	1		1														1.5
750.213	Extortion	20	1					1											3.0
750.321	Manslaughter	15	22	1	1	2	1	4		3		4	6						4.8
750.110	Break & Entering Occ. Dwelling	15	8		1	1		2		1	2		1						3.7
750.530	Robbery, Unarmed	15	7		1	2	1	2				1							2.6
750.88	Asslt. to Rob, Unarmed	15	1									1							5.0
750.520C	Crim Sex Cond, 2nd Degree	15	1			1													2.0
750.423	Perjury - Will Swear Falsely	15	1	1															1.0
750.248	Forgery of Records	14	2			1		1											2.5
750.227B	Poss of Firearm Comm Fel	10	5			5													2.0
750.174	Att Embz Agt Serv Emp 0/\$100	10	1			1													2.0
750.535	Receive Stolen Property	05	9	1	2	3	1		1			1							2.2
750.111	Enter W/O Breaking	05	3	2	1														0.5
750.363	Larc By Conversion 0/\$100	05	2	1		1													1.1

		GRAND															AVG		
		TOTAL	.5	1	1.5	2	2.5	3	3.5	4	4.5	5	10	15	20	25	>25	LIFE	
750.356A	Larceny Fin Mtr Veh or Trailer	05	1			1													2.0
750.413	Unlawfully Driving Away Auto	05	1		1														1.5
400.60	False State - Obtn Relief \$500	04	2	1		1													1.2
750.197C	Jail Break - Armed	04	1			1													2.0
750.136	Cruelty To Children	04	1		1														1.0
750.131A	Checks W/O Acct or Suff Funds	02	2	1		1													0.9
750.520E	Crim Sex Cond, 4th Degree	02	1			1													1.3
750.414	UDAA W/O Int. to Steal	02	1		1														1.0
752.191	Felonious Driving	02	1			1													1.3
750.324	Negligent Homicide	02	1		1														1.0
750.254	Poss of Forged Notes	01	2			2													1.5

B4a Commitments by Age for Men

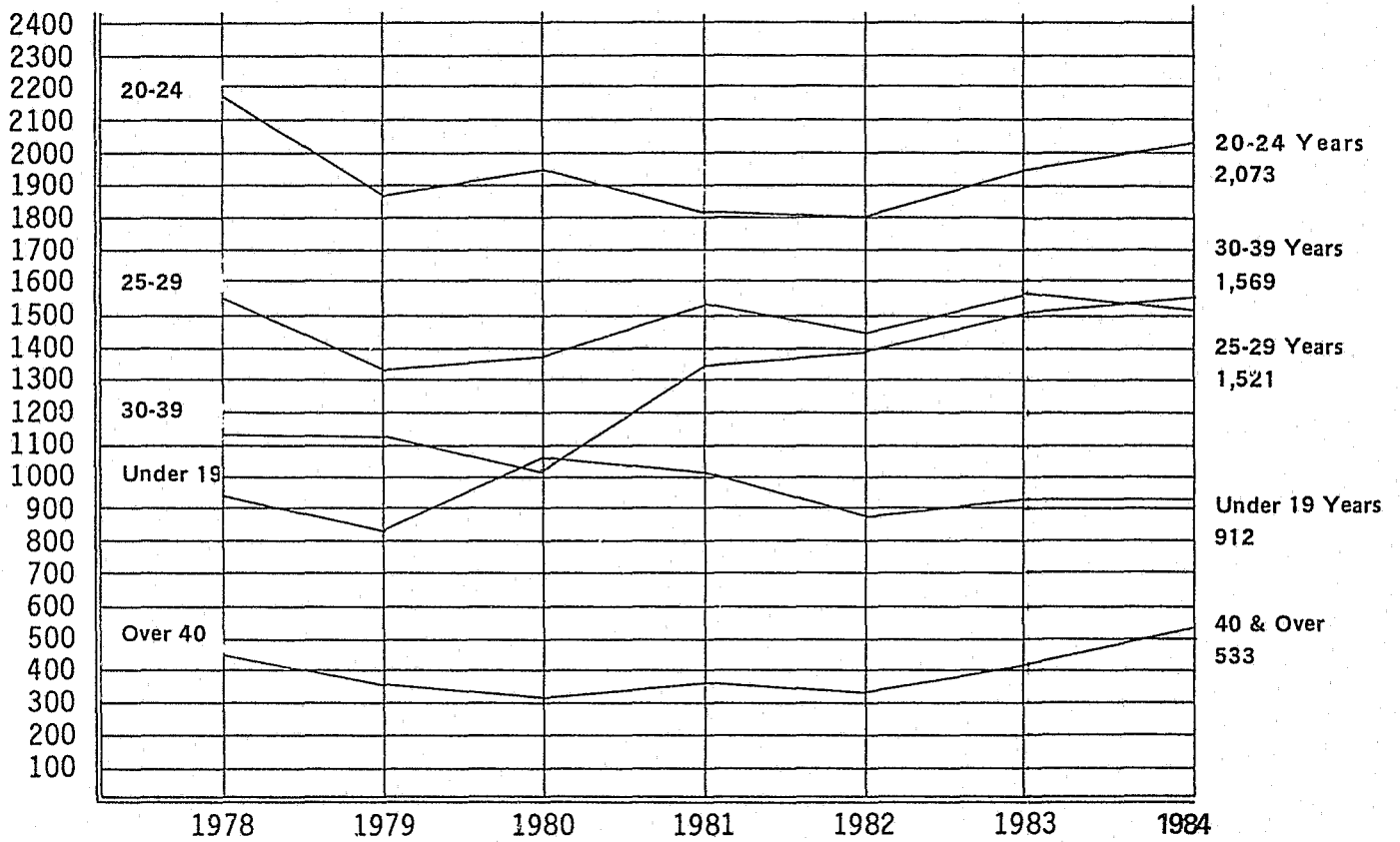

B4b

TOTAL COMMITMENTS: Breakdown by Age, Sex and Race as of December 31, 1984

AGE GROUPS	Total Commitments		Male						Female					
			Total Male		White		Non-White		Total Female		White		Non-White	
	Total	As % Total Commit.	Sub-Total	As % Total Commit.	Sub-Total	% Total Male Commit.	Sub-Total	% Total Male Commit.	Sub-Total	As % Total Commit.	Sub-Total	% Total Female Commit.	Sub-Total	% Total Female Commit.
19 & Under	944	13.2	912	13.8	408	6.2	504	7.6	32	5.9	9	1.7	23	4.2
20-24	2,155	30.1	2,073	31.4	1,053	15.9	1,020	15.4	82	15.1	36	6.6	46	8.5
25-29	1,684	23.5	1,521	23.0	665	10.1	856	13.0	163	30.0	35	6.4	128	23.5
30-39	1,785	25.0	1,569	23.7	690	10.4	879	13.3	216	39.7	54	9.9	162	29.8
40 & Over	584	8.2	533	8.1	306	4.6	227	3.4	51	9.4	18	3.3	33	6.1
Totals	7,152	100.0	6,608	100.0	3,122	47.2	3,486	52.8	544	100.0	152	27.9	392	72.1
Sub-totals as Total Commitments	100.0		92.4		43.7		48.7		7.6		2.1		5.5	

B5a Commitment by Race for Men

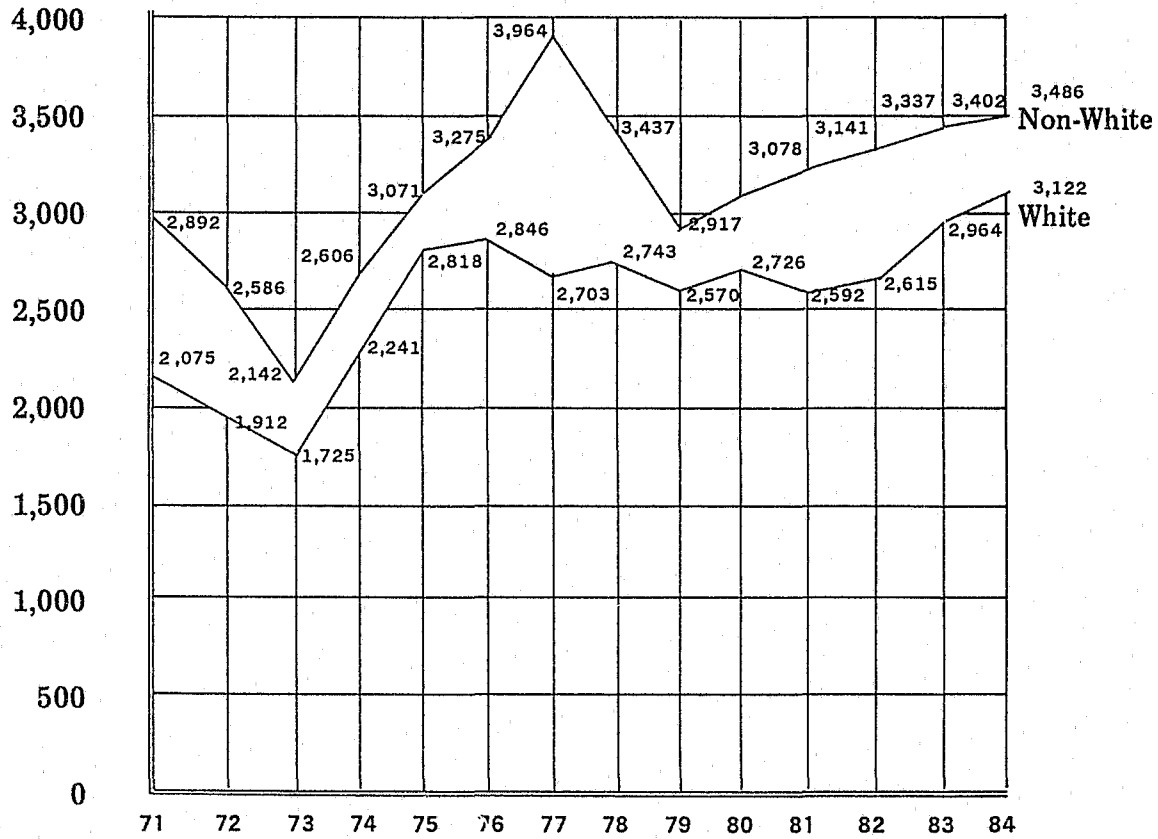

B5b Total 1984 Commitment by Race; Male and Female Percentages

MALE
 White = 3,122
 Non-White = 3,486

FEMALE
 White = 152
 Non-White = 392

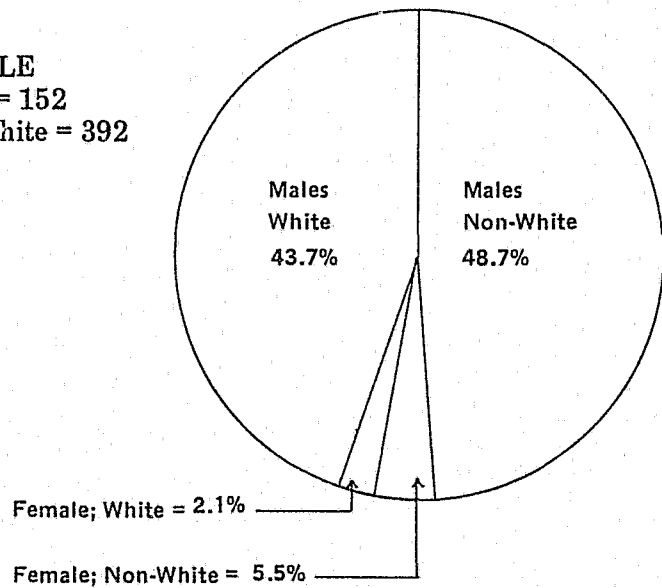

B6

Commitments by Type: Total Commitments 7,152

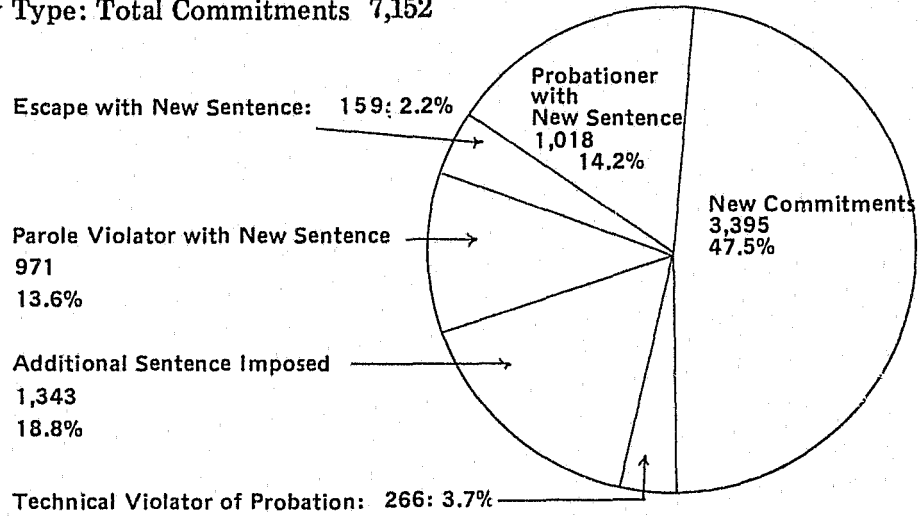

B7a

Commitments: Percent of Crimes Committed in Three Major Crime Areas

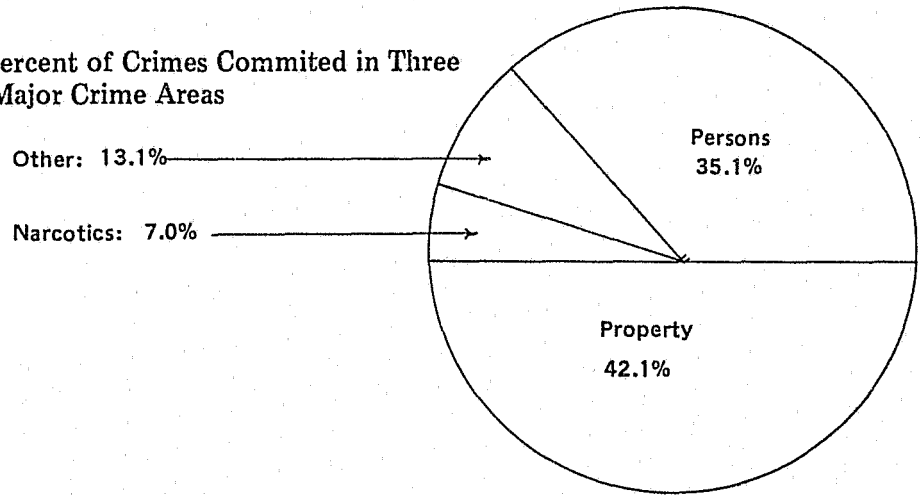

B7b

Commitments: Five year comparison of percent change in crimes against persons as percent of total commitments. (Average percent of total is 37.0%)

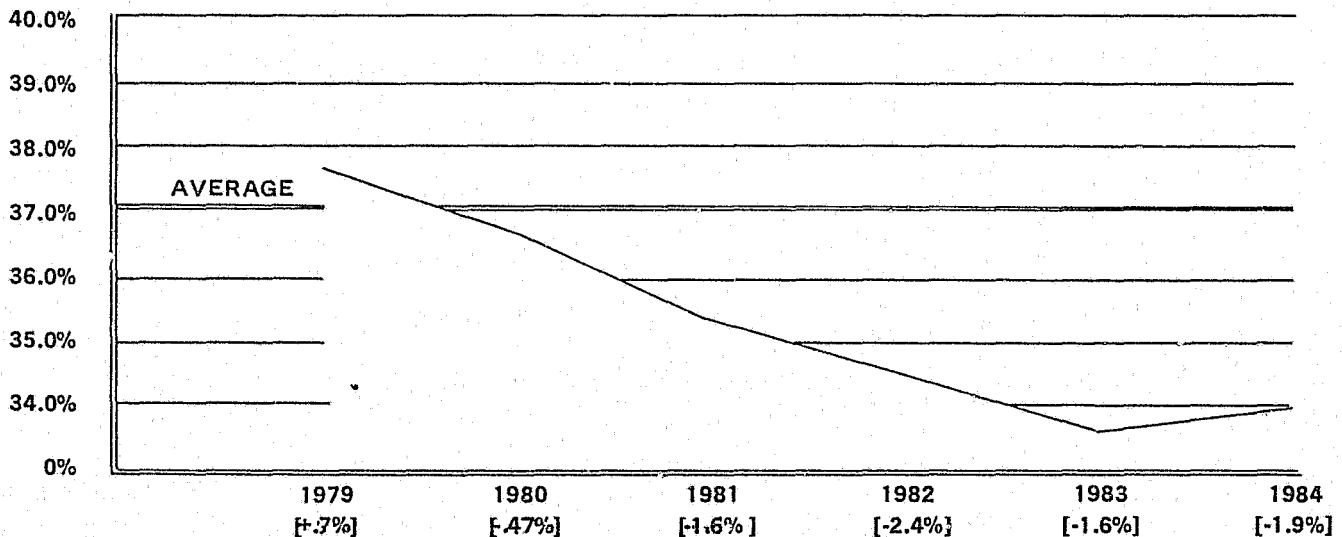

PRISONS AND PRISONERS

The following tables and charts present information on the state's prisons and prisoners. A map shows the location of all prisons and camps as of Dec. 30, 1984. Another section describes each institution.

The C tables count the controlling sentences for persons who were on count at an institution or in the halfway house program the last day of 1984. Temporary releases, furloughs, out-to-court and admissions to the Department of Mental Health are not counted nor are persons who are on a facility count who did not have any active sentence record on the Department's Computer information system.

The C-1 chart contains sentences for both men and women but C-2 contains only women. Besides listing the number of persons serving sentences for the various crimes, the charts contain minimum sentences and averages. Sentences falling between the various categories are grouped into the higher categories. Attempted offenses are given directly below the named offense and are not included in the non-attempt category.

One chart lists the various treatment activities available in Michigan prisons and minimum security camps. Another lists critical incidents.

Charts also in this section show the activities of Michigan State Industries. A chart showing the disposition of major misconducts also can be found in this section.

Charts illustrating activities of the Office of Health Care are not included in the report because a separate statistical document is available from that office.

+ + +



PRISONER POPULATION & MINIMUM TERM DISTRIBUTION (IN YEARS FOR MEN & WOMEN)

		TOTAL	.5	1	1.5	2	2.5	3	3.5	4	4.5	5	10	15	20	25	>25	LIFE	AVG	
GRAND TOTAL - 14461		VIOLATIONS	13256	66	407	592	1151	472	1326	426	783	104	1250	3097	750	510	206	405	1711	7.5
		ATTEMPTS	1205	17	136	194	216	103	211	131	36	7	49	66	14	10	1	4	10	3.0
		Max. Pen.																		
750.529	Robbery Armed	LIFE	2207	12	59	44	128	28	161	32	120	20	243	684	233	154	64	96	129	9.5
			79		4	4	7		10	9	3		7	18	8	4		3	2	7.2
333.7401	Unlawful Man, Del, Poss of Cont Sub	LIFE	439	2	18	38	53	25	65	21	48	7	48	76	13	14	1		10	4.8
			49	1	8	12	9	5	7	2	1		2	1	1					2.3
750.520B	Criminal Sexual Conduct, 1st Degr	LIFE	944		3	2	4	4	27	7	24	3	57	329	130	104	41	80	129	14.0
			20			5	2	3	1	3			1	2	1	2				5.2
333.7403	Poss of Contr Danger Sub 650 Gram	LIFE	73	2	21	19	11	4	10		1			3	1	1				2.3
			11	1	5	4	1													1.1
750.89	Assault to Rob, Armed	LIFE	328	2	9	5	8	1	20	6	23	4	53	98	34	25	11	14	15	9.8
			7						1		2		2	2						7.2
750.349	Kidnaping	LIFE	106	1	1		4	1			3		5	22	16	11	3	11	28	14.2
			7			1	1		1	1	1						1		1	6.4
750.317	Murder, Second Degree	LIFE	1223	2	2		2		6	2	10	2	31	255	178	127	52	142	412	18.2
			7											2	2	2			1	13.5
750.316	Murder, First Degree	LIFE	897															4	893	56.2
			5																5	LIFE
750.531	Bank Safe or Vlt, Robbery	LIFE	77	1			6	1	6	1	4	1	12	26	8	4	5	3	1	9.0
			4						2				1	1						5.2
750.83	Assault W/Intent to Commit Murder	LIFE	356	1	8	5	13	2	8	5	13	1	20	86	41	43	16	39	55	14.5
			3										3	3						6.6
750.520	Rape	LIFE	65										2	12	6	4	4	8	29	20.9
			1																1	LIFE
769.12	Habitual Criminal, Fourth Felony	LIFE	8				1		1		2		1	2		1				6.6
			1													1				20.0
769.10	Habitual Criminal, Second Felony	LIFE	7			2	1	1			1		2							3.0
			1									1								4.3
750.350	Enticing Child Under 14 yr. Age	LIFE	1										1							5.0
			1							1										3.3
750.157A	Conspiracy	LIFE	2						1				1							4.0
			1				1													2.0
750.157B	Incite, Induce to Commit Crime	LIFE	4		1		1								1			1		14.5
750.72	Burning a Dwelling House	20	71		5	2	5	2	7	2	8	1	13	18	8					5.8
			13		2	2	3	1	2	3										2.2
750.110	Break & Entering Occ. Dwelling	15	1059	2	14	40	80	42	114	43	119	17	176	369	32	4	4	2	1	5.5
			65		1	2	4	4	10	4	7	2	15	15	1	1				4.8
750.520C	Criminal Sexual Conduct, 2nd Degree	15	309	2	5	28	10	45	10	32	2	38	132	3	1	1				5.6
			34		1	2	5	6	10	9			1							2.8
750.530	Robbery, Unarmed	15	331		7	12	20	12	36	10	35	2	50	136	7	3	1			5.9
			24				4	2	9	2	1		3	3						3.8
750.520D	Criminal Sexual Conduct, 3rd Degree	15	338		1	8	27	13	37	16	32	2	57	134	5	4			2	5.9
			21			2	1	4	4	5			1	4						3.8
750.321	Manslaughter	15	413	1	14	6	13	5	37	8	22	4	43	255	2	1		2		7.0
			2						1				1							6.5

		TOTAL	.5	1	1.5	2	2.5	3	3.5	4	4.5	5	10	15	20	25	>25	LIFE	AVG
750.249	Uttering & Publishing	14	220	6	11	23	11	36	9	35	5	32	49	2	1				4.3
			60	6	7	10	5	10	8	4		6	4						3.0
750.248	Forgery of Records	14	30		1	3	1	3	3	4		7	7	1					4.6
			11			2	1	6	2										2.8
750.110	Break & Entering Occ. Dwelling	10	817	1	12	51	101	64	50	84	17	133	150						3.7
			323	1	16	35	64	52	74	59	7	6	6						2.6
750.357	Larceny from a Person	10	208		6	11	32	12	31	13	25	1	50	27					3.8
			55	1	4	5	15	8	11	6	2	2	1						2.5
750.218	False Pretense to Defraud	10	42			1	3	3	5	4	4	2	8	12					4.6
			21			4	4	1	6	6									2.5
750.84	Assault Less than Murder	10	259	5	21	6	38	7	32	3	23	4	41	72	5			2	4.2
			7				1	1	1		1		2	1					3.8
750.73	Burning Other Real Property	10	27			2	2	1	7	1	3	2	4	5					4.0
			7		1	1	1	1	1	2			1						2.7
750.520G	Asslt W/Int Commit Crim Sex Conduct	10	152		4	3	21	12	32	7	13	1	24	33	1			1	4.3
			3			1	1		1										2.0
750.136A	Torture by Parent or Guardian	10	2						1	1				2					7.5
			2																3.1
750.174	Att. Embz. Agt. Serv Emp. Over \$100	10	9				1		4	1			1	1					3.3
			2		1		1												1.5
257.254	Possession of a Stolen Auto	10	3					1			1			1					4.6
			1			1													1.5
750.86	Assault with Intent to Main	10	1											1					10.0
			1																3.3
750.535	Receiving Stolen Property	05	243	2	16	37	53	26	48	29	11		10	11					2.7
			53	4	10	15	11	5	5	2		1							1.7
750.413	Unlawfully Driving Away Auto	05	174	1	12	14	35	19	42	35	6		4	6					2.7
			35	1	13	6	8	1	4		1						1		2.4
750.227	Carrying Concealed Weapon	05	116	3	22	17	20	7	20	14	4		3	2	1		2	1	2.8
			35	1	10	8	14			2									1.4
750.356A	Larceny from Mtr. Vehicle or Tr.	05	108		8	11	32	14	11	22	2		4	2	2				2.7
			27		7	2	11	1	3	1			1	1					2.0
750.356	Larceny over \$100	05	181		5	15	47	20	38	26	2	1	16	5	3	2		1	3.1
			24		6	4	7		5	1			1						1.9
750.111	Entering without Breaking	05	88	1	15	8	18	8	17	15	2		3	1					2.4
			14		6	4	2	1	1										1.4
750.193	Escape from Prison	05	61	2	7	4	12	6	14	5	1		5	2	1	1		1	3.2
			9	1		1	3		3		1								2.2
750.224	Mfg. or Poss. Illegal Weapons	05	25		1	2	8	5	2	4	2	1							2.5
			4		1	1	2												1.5
750.362	Larceny by Conversion over \$100.	05	13				5	3	3	1					1				3.4
			3		1		2												1.4
750.253	Uttering Counterfeit Notes	05	9			1	1	2	2	2			1						2.9
			2			2													1.4
800.281	Transport Contraband into Prison	05	1			1													1.5
			1						1										3.0
750.505	Common Law Off. No Expre Penalty	05	5			1	2		2										2.3
			1						1										3.0
750.360	Larceny from a Building	04	498	1	41	90	115	51	124	5	35		25	11					2.4
			111	6	23	46	13	2	16	1	4								1.6

		TOTAL	.5	1	1.5	2	2.5	3	3.5	4	4.5	5	10	15	20	25	>25	LIFE	AVG
750.75	Burning Insured Property	10	3									3							5.0
750.116	Poss of Burglar Tools	10	2										2						7.0
750.336	Indecent Liberties w/Child	10	1									1							5.0
750.160	Disinterment	10	1										1						6.7
750.181	Embz. Prop of Self & Other Person	10	1					1											3.0
750.226	Carry Weapon w/Unlawful Intent	05	8			3	2	2	1										2.5
800.283	Weapon Prohibit Furnish in Prison	05	6			1	1	2		1	1								3.1
257.902	Drunk Driving While on Probation	05	3				2	1											2.6
750.363	Larceny By False Personation	05	2				1						1						4.2
750.338	Gross Indecency Between Males	05	1									1							5.0
257.617	Leaving Scene of P.I. Accident	05	1		1														1.2
257.625	Drunk Driving - Third Offense	04	28	4	6	5	3	6	3				1						2.2
750.136	Cruelty to Children	04	9	1	1	1	1	3	1				1						2.6
750.157N	Theft of Credit Cards	04	8	1	1	4		2											2.0
750.199A	Absconding or Forfeit Bond	04	7		1		2	3	1										2.6
400.60	False State-Obtn Relief Over 0/\$500	04	5	1	1	2				1									2.0
750.357A	Larceny of Livestock	04	2		1	1													1.6
750.377	Mal Dest of Animals	04	1		1														1.5
752.811	Enter Vending Machine	03	5		2	2			1										2.1
570.152	Viol of Build Trust Act	03	1					1											3.0
451.701	Securities, Sale of Unregistered	03	1									1							4.7
750.414	UDAA w/o Int to Steal	02	12	2	8	1	1												1.3
750.520B	Criminal Sex Conduct, 4th Degree	02	12	3	8	1													1.2
750.479	Resist or Obstructing Officer	02	11		7	1	1	2											1.7
750.131	Checks no Funds	02	3		2		1												1.6

35

		TOTAL	.5	1	1.5	2	2.5	3	3.5	4	4.5	5	10	15	20	25	>25	LIFE	AVG
750.324	Negligent Homicide	02	3	1	2														1.2
750.451	Accost & Solicit - Third Offense	02	2		1	1													1.6
752.191	Felonious Driving	02	2		2														1.3
750.362A	Larceny of Rent Mtr. V./Tr. 0/\$100	02	1	1															0.5
750.479A	Mtr. Veh. Opr. Asslt. Police Officer	02	1							1									4.0
750.205	Place Explov. by Prop. W/I Disch.	01	3		1	1							1						4.5
750.335A	Indecent Exposure	01	2			1							1						5.6
750.457	Accept Earn of Prostitution	01	2									1	1						5.7
750.206	Place Explov W/I to do Damage	01	1													1			25.0
205.509	Poss & Trans Untaxed Cigarettes	01	1					1											3.0
750.250	Forgery of Notes Etc	01	1										1						7.0
750.349A	Prisoners Taking Another Hostage	01	1															1	LIFE
752.543	Unlawful Assembly	01	1	1															1.0
750.197	Break Esc. Jail or Att prior to trial	01	1										1						10.0
750.254	Poss of Forged Notes	01	1		1														1.5
333.7410	Distrib to Minors	01	1		1														1.5
750.207	Use Explosives W/I Destroy/Injure	01	1												1				20.0
750.209	Place Fowl Subst W/I Injure, Coerce	01	1										1						6.0
750.448	Accosting, Soliciting for Immoral	3 Mo/\$100	1			1													2.0

SS

C2 FEMALE PRISONER POPULATION & MINIMUM TERM DISTRIBUTION

		TOTAL	.5	1	1.5	2	2.5	3	3.5	4	4.5	5	10	15	20	25	>25	LIFE	AVG
GRAND TOTAL - 683	VIOLETIONS	581	6	46	50	106	29	76	9	41	4	42	94	15	9	4	5	45	4.6
	ATTEMPTS	102	2	14	36	18	3	15	7	3			1		2			1	2.2
	Max. Pen.																		
333.7401 Unlawful Man. Del. Poss. of Cont. Sub.	LIFE	25		2	4	5	2	4	1	1		2	2		1			1	3.6
		4			1	2	1												1.9
333.7403 Poss of Contr Danger Sub 650 Gram	LIFE	10	1	4	1	2	1								1				3.2
		3		2	1														1.1
750.317 Murder, Second Degree	LIFE	66		1		1				3	1	6	19	10	6	2	3	14	12.2
		2													2				19.0
750.529 Robbery, Armed	LIFE	53		11	3	8	2	4	1	4		4	12	2				2	4.1
		2						1										1	3.0
750.72 Burning a Dwelling House	20	3		1		1						1							2.6
		1				1													2.0
750.520D Criminal Sexual Conduct, Third Degree	15	1			1														1.1
750.249 Uttering and Publishing	14	17		3	3	3		2	4	1			1						2.6
750.248 Forgery of Records	14	2						1	1										3.1
750.357 Larceny from a Person	10	6			2	1	2	1											2.1
750.110 Break & Enter Occ. Dwelling	10.	3			3														1.5
750.218 False Pretense to Defraud	10	2			1	1													1.7
750.84 Assault Less than Murder	10	1						1											3.0
750.86 Assault with Intent to Main	10	1							1										3.3
750.356 Larceny over \$100	05	5		1	2	1		1											1.7
750.316 Murder, First Degree	LIFE	26																26	LIFE
750.89 Asslt. to Rob, Armed	LIFE	13		1	2	1							7		1	1			8.3
750.83 Asslt. W/I to Commit Murder	LIFE	12		1				1		1		1	4	1			2	1	11.3
750.520B Criminal Sex Conduct, First Degree	LIFE	6											4	1		1			12.3
750.349 Kidnapping	LIFE	5	1			1	1						1					1	2.6
769.12 Habit. Criminal, 4th Felony	LIFE	2				1				1									3.0
769.10 Habit. Criminal, 2nd Felony	LIFE	1			1														1.3
750.350 Enticing Child Under 14 Yrs.	LIFE	1										1							5.0
769.11 Habit. Criminal, 3rd Felony	LIFE	1										1							5.0
750.531 Bank Safe or Vlt. Robbery	LIFE	1											1						6.0

68

C3

RACIAL COMPOSITION AS OF DECEMBER 31, 1984: Percent Breakdown

LOCATION	WHITE	NON-WHITE
Cassidy Lake Technical School	27.3	72.7
Huron Valley Woman's Facility	29.9	70.1
Female Corrections Centers	18.8	81.2
Mental Health	52.7	47.3
Michigan Reformatory	33.2	66.8
Michigan Training Unit	49.7	50.3
Riverside Correctional Facility	57.0	43.0
Marquette Branch Prison	40.2	59.8
Michigan Intensive Program Center	12.2	87.8
Kinross Correctional Facility	52.9	47.1
State Prison of Southern Michigan	40.3	59.7
Muskegon Correctional Facility	45.0	55.0
Reception and Guidance Center (SPSM)	54.3	45.7
Upper Camps (Male)	37.3	62.7
Lower Camps (Male)	35.8	64.2
Men's Corrections Centers	36.3	63.7
Michigan Dunes Correctional Facility	41.4	58.6
Riverside Reception Center	55.6	44.4
Camp-Female	23.1	76.9
Phoenix Correctional Facility	33.4	66.6
Resident Homes (Male)	71.4	28.6
Resident Homes (Female)	30.4	69.6
Huron Valley Men's Facility	27.2	72.8
Parolees	43.2	56.8
TOTAL	41.8	58.2

C4

FACILITIES SUMMARY: All Prisoner Movements in 1984

Population & Movement	Total Priser	Total Male	Total Female	CORR																	COR			
				CLT	DCF	HVM	HVV	KCF	MBP	MCF	MIPC	MTU	RCF	RG&C SPSM	RMI	RG&C RCF	SPSM	XCF	CAMP MALE	CTR MALE	RES HMM	CAMP FML	COR CNT FML	RES HMF
BEGINNING POPULATION	14472	13810	662	229	320	377	428	647	776	583	80	767	522	409	1181	82	4772	285	1333	968	479	89	86	59
Tech Viol of Prob	266	236	30				30							140		96								
Probationers w/new Sent	1018	926	92				92							582		343								
New Commitment	3396	3174	222			2	222		70					2468		634								
Parole Viol w/new Sent	971	915	56		1		56		11	1		1		858	2	41								
Escape w/new Sentence	159	141	18				18		1			2		127	1	10								
Added Sent Imposed	1344	1218	126		21	2	125	2	15	5	6	94	7	863	62	141						1		
TOTAL COMMITMENTS	7154	6610	544		22	4	543	2	98	6	6	97	7	5038	65	1265						1		
MOVEMENT IN																								
Visitor In (1)	2291	2291						10	31	1				334	52	1859	4							
Ret'd While on Parole	6	5	1				1							2		1			2					
Ret'd Tech Parole Viol	843	807	36				36	1	3					320		6		477						
Ret'd from Court	2348	2118	230	23	69	21	189	11	16	90	2	141	60	321	115	36	741	313	125	24	10	36	3	2
Escaper Returned	936	823	113	4			103		4				1	490	31	24	2	170	5	66	26		5	5
Ret'd Mental Health	104	93	11				11			1			85	5	1			1						
Transfer In (2)	28104	26639	1465	860	703	282	195	1105	1048	908	160	1187	819	1050	1393	189	6640	224	3567	4859	1645	691	386	193
TOTAL MOVEMENT IN	34632	32776	1856	887	772	303	535	1127	1102	1000	162	1328	965	2522	1592	2115	7387	1185	3697	4951	1681	727	394	200
PAROLED																								
Reinstated on Parole	58	57	1				1			4		3	2	5			10	32	1					
First Parole	5609	5246	363	45	14	18	55	138	63	128		145	63	11	208		1002	69	465	1873	1004	44	160	104
Paroled in Custody	142	137	5	2	13	2	5	7		12		10	1	3	8		49	25	3	2				
Paroled on Same Term	134	132	2		1		2	1		7			2				52	65	3	1				
TOTAL PAROLED	5943	5572	371	47	28	20	63	146	63	151		158	68	19	216		1113	191	472	1876	1004	44	160	104
RELEASES																								
Additional Sent Process	61	61				3		1	15				1	1			1	39						
Visitor Out (3)	1958	1958						10	18	1				24	47	1055	3							
Disch'd on Max. after Parole & Return	50	49	1				1						2	3	1		23	18	1	1				
Death on Temp Release	12	12				1							2	2			7							
Death in Institution	12	12															3			8	1			
To Court on Writ	3590	3241	349	28	107	24	280	48	67	117	11	260	68	408	196	63	1060	368	156	154	96	43	15	11
Disch'd on Max. w/o Prl	295	273	22	2	2	3	5	9	5	5		6	13	2	9		87	7	9	53	61	1	7	9
Escape from Institution	7	7				3							1		1		1	1						
Escape Temporary Release	1	1																	1					
Escape Ltd. Furlough	4	4																	4					
Escape Walkaway	1181	1030	151	36					1					38			70	1	126	544	214	13	104	34
Transfer Out	28441	26966	1475	743	650	241	772	765	1086	725	152	991	758	7086	1154	1453	4958	522	2900	2373	409	560	98	45
To Mental Health/other Crim. Just. Agency	99	89	10			2	10		1				48	10		1	25			1	1			
TOTAL RELEASED	35711	33703	2008	809	759	277	1068	833	1193	848	163	1257	893	7536	1446	3372	6238	956	3197	3144	782	617	224	99
ENDING POPULATION	14604	13921	683	260	327	387	375	797	720	590	85	777	533	414	1176	90	4808	323	1361	899	374	156	96	56

- (1) Prisoner in Transit but still in prison system
- (2) Movement from one facility to another
- (3) Prisoners in transit out of prison system

C5

1984 CRITICAL INCIDENTS IN PRISON

	TOTAL	CAMP	CLTS	DCF	HVMF	HVWF	KCF	MBP	MCF	MIPC	MRI	MTU	XCF	RCF	RGC	SPSM
Incidents Filed	4081	50	281	55	261	174	160	231	385	103	600	369	85	392	56	879
Deaths	6				1									1		4
Homicides	1															1
Attempts	1															1
Suicides	1													1		
Attempts	352	1		3	26	32	13	8	24	1	57	27	3	92	6	59
Other	4				1											3
Assaults	828	25	12	14	63	34	23	73	29	27	147	56	10	104	27	184
Against Staff	497	9	2	4	42	28	18	62	5	23	73	31	1	102	11	86
While Resisting	240	5	1	3	12	5	7	32	3	16	36	19		70	5	26
Serious Injury	12	1			1			3		2	2			2		1
Weapon	55				8	3		9		4	11	1		14		5
Not While Resisting	257	4	1	1	30	23	11	30	2	7	37	12	1	32	6	60
Serious Injury	15	1			2		1	3			1			1		6
Weapon	97	1			10	8	5	11		4	21			10		27
Against Visitor	1						1									
Against Prisoner	330	16	10	10	21	6	4	11	24	4	74	25	9	2	16	98
Attempts	7								1		2	2		2		
Serious Injury	107	7	2	5	8			5	6	3	22	2	2		3	42
Weapon	152	8	2	3	13	2		7	7	5	34	10				61
Threatening Behavior	38	1			2		1		1	2	7			18	2	4
Riot/Mutiny/Strike	13							4		2					2	5
Attempts	7					1	1				1	2				2
Escapes	45	2	25		6	4			1		1		2	1		3
Attempts	22			2	1	3	1	1	1			7	1	1	1	3
From Secure Institutions*	14				3	4			1		1		2	1		2
From Minimum Custody	31	2	25		3											1
Staff Use of Mace or Gas	44				9	2		2	1	5	2	1			6	16
Staff Use of Excessive Force	6								1			2		1		2
Staff Use of Any Force	330	7	1	16	22	12	33	6	7	18	66	62	4	63	2	11
Discharge of Firearm	18				6					1						11
Smuggling Contraband	125		5		44			4	3			41				28
Staff	0		0		0			0	0			0				0
Visitor	0		0		0			0	0			0				0
Prisoner	125		5		44			4	3			41				28
Substance Abuse	1186		53	14	49	39	72	55	132	2	106	135	24	32		473
Alcohol	426		12	1	26	13	16	29	32	2	34	22	1	25		213
Narcotic	289		18	0	1	13	13	5	2	0	70	107	2	2		56
Hallucinogenic/Non-Narcotic	471		23	13	22	13	43	21	98	0	2	6	21	5		204
Theft/Cell & Other	399		66		4	7	5	18	140	4	109	1	18	26		1
Extortion/Strongarming	70		62				1	2	3			1	1			
Possession of Money	114		25	1	2	7	3	1	6		11	5	5	2		46
Vandalism	210		6		13	14		50	4	34	77		5	7		
Fires	65	3	1		4	13	2	5	3	4	3	5	1	9	4	8
Accidental	14	2				3			1		3	3				2
Arson	47	1	1		4	9	1	5	2	4		1	1	9	4	5
Attempts	2						1									1
Suspected	2					1						1				
Accidents	50	2	13		2	1		1	3		3	8	8	4	2	3
Other	152	9	12	5	7	5	5	1	26	3	10	16	3	31	4	15

*Some escapes occurred while prisoners were outside the prison at hospitals, on details or under types of escort.

C6 FACILITY POPULATIONS AS OF DECEMBER 31, 1984: 5 Year Comparison

Year	Grand Total	R&GC SPSM	SPSM	MR (RMI)	MTU	MARQ	MIPC	MUSKE-GON	CASS LAKE	CAMPS Male	PHOE-NIX	R&GC RCF	RIVER SIDE	KIN-ROSS	DUNES	HVM	CORR. C. M	RES. HM. M.	HVW	CAMPS Female	CORR. C. Fin	RES. HM. F.
1980	15,124	337	5,244	1,336	759	850	87	614	245	1,103	306	94	585	618	368		975	969	368	64	113	71
1981	14,964	426	5,068	1,326	764	884	72	582	243	1,205	305	96	550	643	328	308	755	791	380	79	96	63
1982	14,737	396	4,883	1,192	773	855	84	613	237	1,285	288	82	542	643	315	384	889	648	414	82	90	42
1983	14,470	423	4,802	1,192	774	591	82	591	231	1,292	287	98	527	646	323	371	901	457	428	80	96	64
1984	14,604	414	4,808	1,176	777	720	85	590	260	1,361	323	90	533	797	327	387	899	374	375	156	96	56

	Camps	Cass Lake	Dunes	HVM	HVW	Kin-ross	Marq MIPC	MR	MTU	Musk-egon	Phoe-nix	River-side	SPSM	TOTAL
ACADEMIC														
Basic Education 0-8	71	139	67	46	64	38		134	265	126	38	20	278	1286
GED Preparation	135	22	47	54	46	57		174	168	161	27	56	327	1274
Life Role Competencies	136	43	29	100	8	23			86	123	13	5	24	590
Chapter I - ECIA		71		12				71	186					340
College - Academic	194			36	35	80	75	181	50	75	40	42	838	1646
4th FRIDAY STUDENT COUNT	183	182		155	119	246		307	512	403	90	103	967	3267
VOCATIONAL														
Air Cond., Heating & Ventil.									21					21
Appliance Repair	30	19												49
Auto Body Repair						24			23					47
Auto Mechanic	25	32				30	12	18	20	80			38	255
Building Trades	14		23	39		30			37					143
Custodial		29							30				46	105
Dental Lab	19												32	51
Drafting									25					25
Electric Wiring													14	14
Electronics Technology			18											18
Food Service	26		17	18	10	20		25		40	13			169
Graphic Arts					10			22					13	45
Industrial Hydraulics													14	14
Intro to Tools & Bldg. Trades					9				22		28			59
Landscaping													40	40
Machine Tool Operation									15					15
Meat Processing													18	18
Office Occupations		28	22	38	11				33			26		158
Optical Mechanic													40	40
Small Engine Repair								21					32	53
TV Production										30				30
Welding		31						26	39					63
OJT & APPRENTICESHIPS				4	26	12	26							218
														286
													Total	1814
THERAPEUTIC														
Alcoholics Anonymous	164	26	42	27	11	80	58	88	45	58	27	11	321	958
Group Counseling - Staff	127	120	9		26	24	39		56	55	10	36		502
Group Counseling - Volunteers		56			16		15	75		20		51		233
Psychotherapy - Group	76	58	8	26	48	86	81	85	45	47	20	24	717	1321
Psychotherapy - Individual	8		13	4	3	52	21	11	3	8	20	9	5	157
Substance Abuse	182		28		24	24			85	30	20	22	111	526
													Total	3697
PSYCHOTHERAPY WAITING LIST	27		33	121	4	156	242	280	260	175		86	703	2087
ACTIVITIES														
Child of Month Club						50								50
Hispanic/Native American Groups					11			18		15		10	77	131
Hobbycraft	117			43	40	98	200	118	20	40		120	523	1319
JayCeers	15	26	45	30		36	50	38	84	35		21	71	451
Lifer Groups			7										57	64
Music Programs			35	12	30	27			51	25		4		184
NAACP													188	188
Public Works	310										5			315
Twin Cities													18	18
Veterans Groups													145	145
WORK PASS	67													67
													Total	2932

MAP

Facilities Operated by the Michigan Department of Corrections as of Dec. 31, 1984.

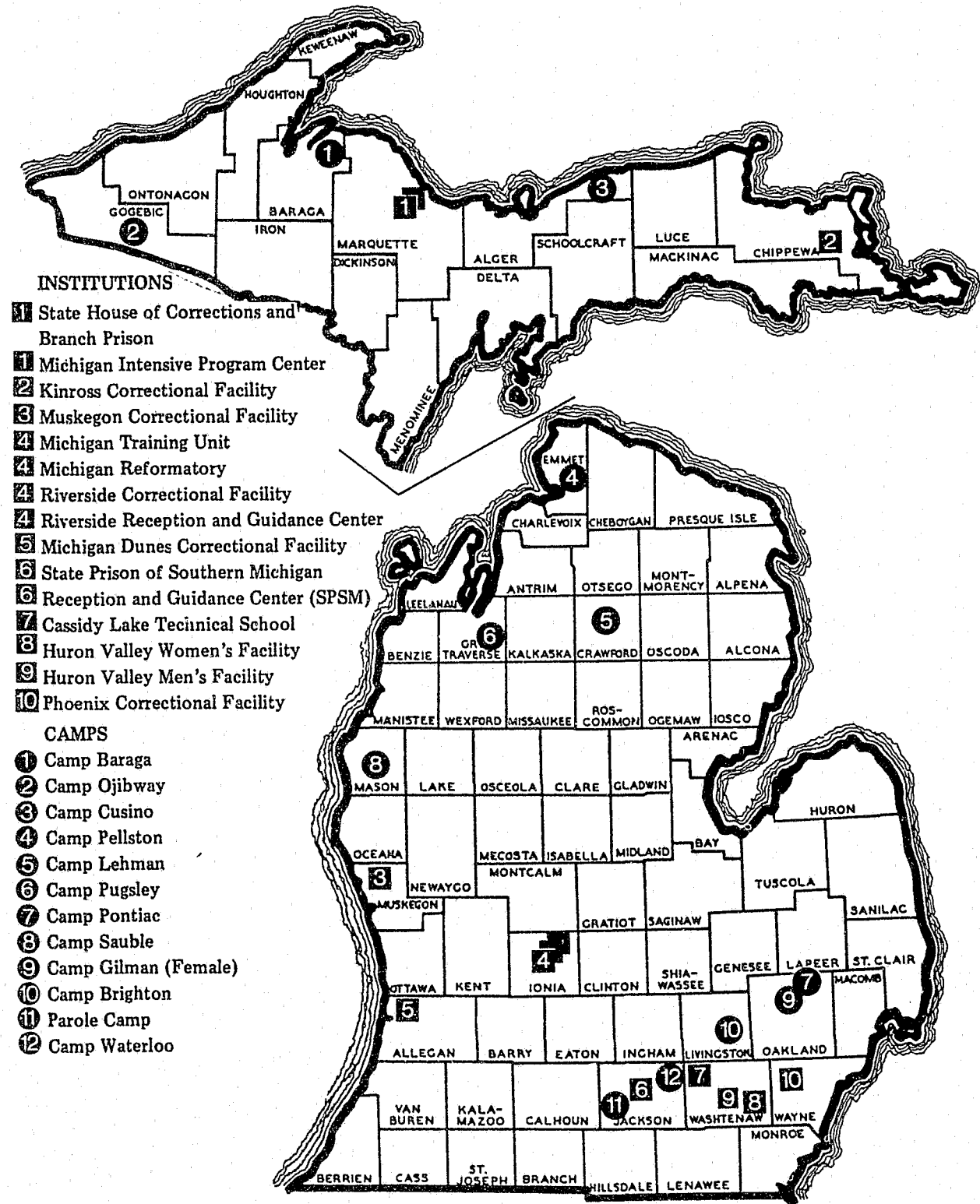

DESCRIPTION OF INSTITUTIONS

MICHIGAN INTENSIVE PROGRAM CENTER

Superintendent Jack Bergman
 Marquette, Michigan 49855
 (906) 226-6531
 OPENED: 1973
 TEMPORARY EMERGENCY CAPACITY:
 January, 1985: 88
 POPULATION: January, 1985: 86
 AGE LIMITS: 17 and up
 Maximum security for select male offenders
 Appropriation for 1984-85: \$17,001,552
 (Included in Marquette Branch Prison budget.)
 *Appropriated 1984-85 per capita for prisoner
 care and custody: \$51.97 (Included in MBP figure)

STATE HOUSE OF CORRECTION AND BRANCH PRISON

Superintendent Theodore Koehler
 Marquette, Michigan 49855
 (906) 226-6531
 OPENED: 1889
 TEMPORARY EMERGENCY CAPACITY:
 January, 1985: 734 (E Block being remodeled)
 POPULATION: January, 1985: 721
 AGE LIMITS: 21 and up
 Maximum security (with minimum security
 unit outside the walls)
 Appropriation for 1984-85: \$16,288,100
 *Appropriated 1984-85 per capita for prisoner
 care and custody: \$51.40

KINROSS CORRECTIONAL FACILITY

Superintendent Robert E. LeCureux
 Kincheloe Air Force Base, Michigan 49788
 (906) 495-2282
 OPENED: January, 1978
 TEMPORARY EMERGENCY CAPACITY:
 January, 1985: 904
 POPULATION: January, 1985: 797
 AGE LIMITS: 21 and up
 Medium security
 Appropriation for 1984-85: \$13,229,700
 *Appropriated 1984-85 per capita for prisoner
 care and custody: \$57.72

RECEPTION AND GUIDANCE CENTER - SPSM

Superintendent John Prelesnik
 4000 Cooper Street
 Jackson, Michigan 49201
 (517) 788-7560
 OPENED: 1956
 TEMPORARY EMERGENCY CAPACITY:
 January, 1985: 411
 POPULATION: January, 1985: 375
 All male commitments 21 or over are processed
 here.
 Appropriation for 1984-85: \$60,322,100
 (Included in appropriation for State Prison of
 Southern Michigan)
 *Appropriated 1984-85 per capita for prisoner
 care and custody: \$34.29 (Included in figure
 for SPSM)

CASSIDY LAKE TECHNICAL SCHOOL

Superintendent John Staten
 RFD No. 1, Waterloo Road
 Chelsea, Michigan 48118
 (313) 475-1368
 OPENED: 1944
 TEMPORARY EMERGENCY CAPACITY:
 January, 1985: 266
 POPULATION: January 1985: 250
 AGE LIMITS: Under 21 and over 30 who need
 academic or vocational training
 Minimum security cottages
 Appropriation for 1984-85: \$3,541,097
 (Included in Camp Program appropriation)
 *Appropriated 1984-85 per capita for prisoner
 care and custody: \$34.38

PHOENIX CORRECTIONAL FACILITY

Superintendent Lloyd May
 47900 Five Mile Road
 Plymouth, Michigan 48170
 (313) 455-6300
 OPENED: August 13, 1980
 TEMPORARY EMERGENCY CAPACITY:
 January, 1985: 311
 POPULATION: January, 1985: 315
 AGE LIMITS: All Ages
 Medium security
 Appropriation for 1984-85: \$7,011,900
 *Appropriated 1984-85 per capita for prisoner
 care and custody: \$61.77

MICHIGAN DUNES CORRECTIONAL FACILITY

Superintendent Pamela K. Withrow
 6605 West 138th Avenue
 Holland, Michigan 49423
 (616) 335-5801
 OPENED: July 17, 1978
 TEMPORARY EMERGENCY CAPACITY:
 January, 1985: 328
 POPULATION: January, 1985: 327
 AGE LIMITS: 21 and older
 Medium Security
 Appropriation for 1984-85: \$7,463,600
 *Appropriated 1984-85 per capita for prisoner
 care and custody: \$62.34

STATE PRISON OF SOUTHERN MICHIGAN

Warden Dale Foltz
 4000 Cooper Street
 Jackson, Michigan 49201
 (517) 788-7560
 OPENED: 1839; new prison: 1926
 TEMPORARY EMERGENCY CAPACITY:
 January, 1985: 4896
 POPULATION: January, 1985: 4799
 AGE LIMITS: 21 and up
 Close, medium and minimum security
 Appropriation for 1984-85: \$67,798,500
 *Appropriated 1984-85 per capita for prisoner
 care and custody: \$35.07

MUSKEGON CORRECTIONAL FACILITY

Superintendent H. Gary Wells
 2400 South Sheridan
 Muskegon, Michigan 49442
 (616) 773-3201
 OPENED: 1974
 TEMPORARY EMERGENCY CAPACITY:
 January, 1984: 589
 POPULATION: January, 1985: 589
 Age Limits: 21 and over
 Medium Security
 Appropriation for 1984-85: \$9,545,700
 *Appropriated 1984-85 per capita for
 prisoner care & custody: \$42.58

MICHIGAN TRAINING UNIT

Superintendent James Yarborough
 Ionia, Michigan 48846
 (616) 527-3100
 OPENED: 1958
 TEMPORARY EMERGENCY CAPACITY:
 January, 1985: 780
 POPULATION: January, 1985: 777
 AGE LIMITS: Under 21
 Medium Security
 Appropriation for 1984-85: \$10,019,000
 *Appropriated 1984-85 per capita for prisoner
 care and custody: \$35.46

MICHIGAN REFORMATORY

Warden John Jabe
 Ionia, Michigan 48846
 (616) 527-2500
 OPENED: 1877
 TEMPORARY EMERGENCY CAPACITY:
 January, 1985: 1175
 POPULATION: April, 1985: 1163
 AGE LIMITS: Under 21
 Close security (with minimum security unit
 outside the walls)
 Appropriation for 1984-85: \$17,113,500
 Appropriation for 1984-85 per capita for
 prisoner care and custody: \$38.97

CORRECTIONS CAMP PROGRAM

Superintendent William Grant
 6000 Maute Road
 Grass Lake, Michigan 49240
 (313) 475-1358
 12 camps throughout Michigan (one camp
 is for women)
 TEMPORARY EMERGENCY CAPACITY:
 January, 1985: 1093
 POPULATION: January, 1984: 1332
 AGE LIMITS: All ages
 Appropriation for 1984-85: \$18,000,000
 *Appropriated 1984-85 per capita for
 prisoner care and custody: \$31.59

HURON VALLEY WOMEN'S FACILITY

Superintendent Tekla Miller
 3511 Bemis Road
 Ypsilanti, Michigan 48197
 (313) 434-6300
 OPENED: August, 1977
 TEMPORARY EMERGENCY CAPACITY:
 January, 1984: 326
 POPULATION: January, 1985: 384
 AGE LIMITS: All ages
 Close and Medium Security
 Appropriation for 1984-85: \$6,901,600
 *Appropriated 1984-85 per capita for
 prisoner care & custody: \$58.00

HURON VALLEY MEN'S FACILITY

Warden Robert Redman
 3201 Bemis Road
 Ypsilanti, Michigan 48197
 (313) 434-7775
 OPENED: August 20, 1981
 TEMPORARY EMERGENCY CAPACITY:
 January, 1985: 411
 POPULATION: January, 1985: 382
 AGE LIMITS: All ages
 Maximum Security
 Appropriation for 1984-85: \$10,403,729
 *Appropriated 1984-85 per capita for
 prisoner care and custody: \$89.85

RIVERSIDE CORRECTIONAL FACILITY

Superintendent Denise Quarles
 777 Riverside Drive
 Ionia, Michigan 48846
 (616) 527-0110
 OPENED: January, 1977
 TEMPORARY EMERGENCY CAPACITY:
 January, 1985: 570
 POPULATION: January, 1985: 537
 AGE LIMITS: All ages
 Close security
 Appropriation for 1984-85: \$13,426,900
 *Appropriated 1984-85 per capita for
 prisoner care and custody: \$57.21

RECEPTION AND GUIDANCE CENTER - RIVERSIDE

Superintendent Robert Mayer
 777 Riverside Drive
 Ionia, Michigan 48846
 (616) 527-0110
 OPENED: May, 1979
 TEMPORARY EMERGENCY CAPACITY:
 January, 1984: 94
 POPULATION: January, 1985: 94
 All male commitments under 21 are pro-
 cessed here.
 Appropriation for 1984-85 per capita for
 prisoner care and custody: \$57.21
 (Included in figure for Riverside Correc-
 tional Facility)

C8 Prison Population and Rated Capacity as of December 1984

NOTE: Capacity does not include temporary housing; both population and capacity include Community Residential Programs.

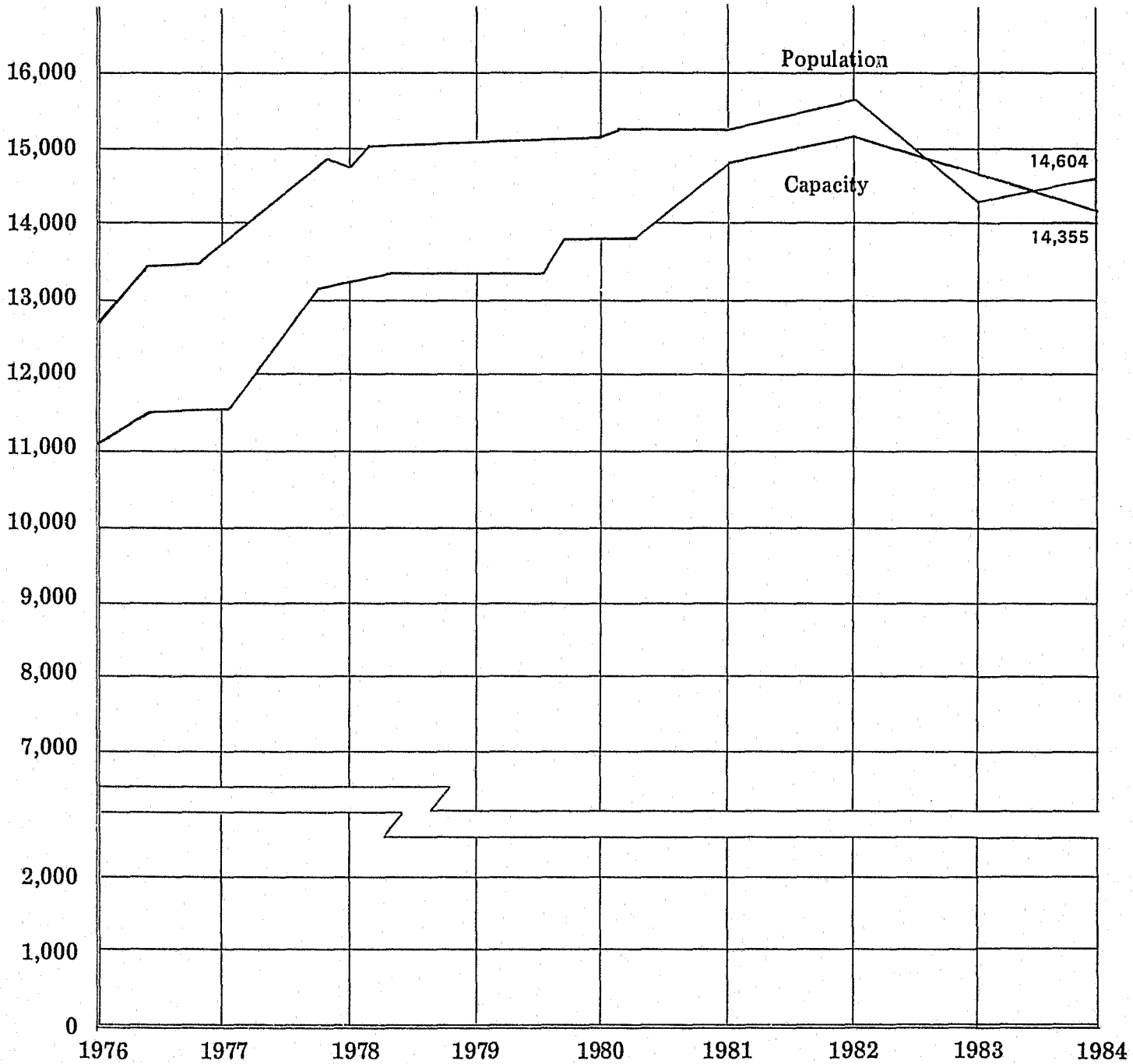



MICHIGAN STATE INDUSTRIES -- Total Prisoner Earnings

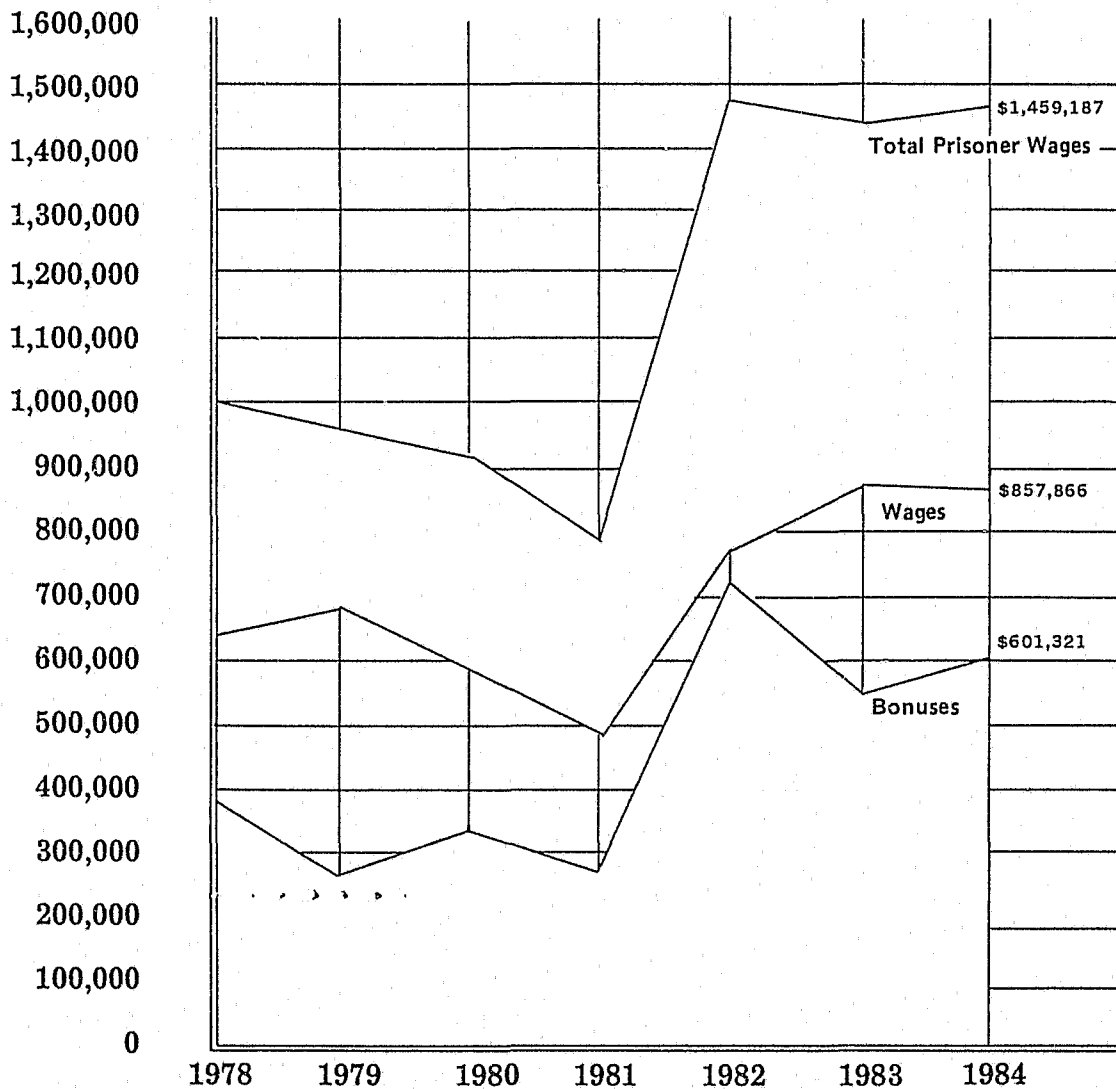

NOTE: Earnings generated after 1981 are retained by Michigan State Industries.



M.S.I. Five Year Sales History - Three Largest Factories

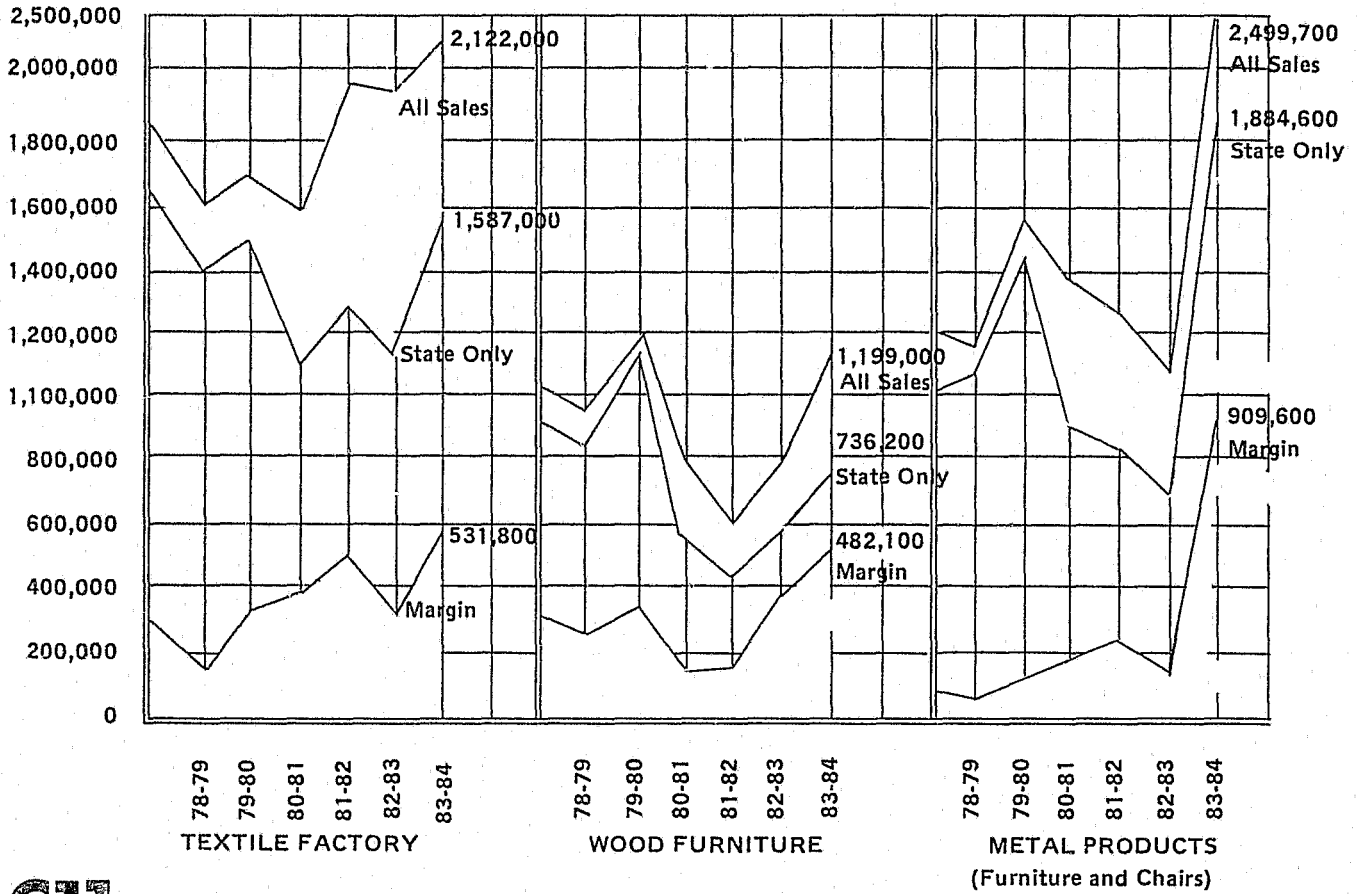

M.S.I. Sales - Earnings

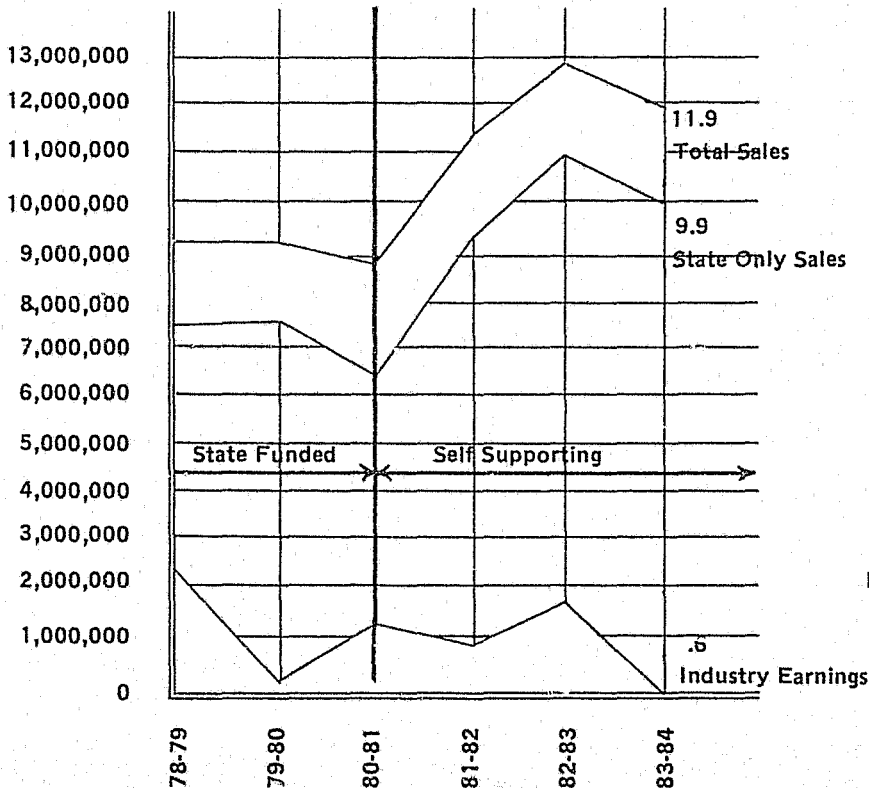

NOTE: Earnings generated after 1981 are retained by Michigan State Industries.

C12

M.S.I. PRISONERS EMPLOYED DURING 1984

	Beginning Prisoners On Assignment	Hired	Released	Ending Prisoners On Assignment	Turnover
JACKSON FACTORIES					
Textile	181	254	222	213	
Carton	2	7	6	3	
Shoe	58	42	42	58	
License Plate	95	37	103	29	
Metal Furniture	73	87	64	96	
Sign	22	26	23	25	
Chair	19	34	24	29	
Laundry	90	81	95	76	
Miscellaneous	65	58	47	76	
TOTAL	605	626	626	605	103.5%
HURON VALLEY FACTORY					
Tab	28	39	39	28	
TOTAL	28	39	39	28	139.3%
MUSKEGON FACTORY					
Vinyl Products				4	
TOTAL				4	
IONIA FACTORIES					
Cotton Garment	27	17	19	25	
Wood Furniture	91	135	106	120	
Laundry	53	68	67	54	
Miscellaneous	6	5	5	6	
TOTAL	177	225	197	205	96.1%
MARQUETTE FACTORIES					
Work Garment	29	67	45	50	
Miscellaneous	2			2	
TOTAL	31	67	45	52	86.5%
TOTAL OF ALL FACTORIES	841	957	907	894	101.5%

C13

M.S.I. PRISONER WAGES - BONUSES - MAN HOURS - SALES

FISCAL YEAR ENDING	AVERAGE DAILY WAGE W/O BONUS	AVERAGE DAILY WAGE W/ BONUS	TOTAL AVERAGE PAYROLL W/O BONUS	TOTAL BONUS PAID	TOTAL PRISONER EARNINGS	TOTAL SALES (Incl. Lic. Plts)
Sept. 1979	3.30	4.75	670,642	293,376	964,018	9,137,990
Sept. 1980	3.43	5.21	599,710	339,405	939,115	9,202,292
Sept. 1981	3.62	5.55	492,604	278,891	771,495	7,743,996
Sept. 1982	4.74	8.73	766,712	707,194	1,473,906	11,145,015
Sept. 1983	4.35	7.19	866,794	566,825	1,433,619	12,901,122
Sept. 1984	4.01	6.82	857,866	601,321	1,459,187	11,944,473

* Factored for 12 months, also major license plate year.

C14 MAJOR MISCONDUCT YEARLY TOTALS - 1984

Inst.	Total Cases	Total Charges	Charges Not Guilty	Charges Dismissed	% of Chrgs Not Guilty*	% of Chrgs Dismissed*	Total % Not Guilty and Dismissed**
Camps	1,763	1,918	240	136	13%	7%	20%
CLTS	773	849	85	55	10%	6%	16%
Coimn. Proq.	9,615	11,190	447	794	4%	7%	11%
Dunes	1,083	1,157	47	60	4%	5%	9%
HVMF	1,402	1,417	75	37	5%	3%	8%
HVWF	1,609	1,765	218	209	12%	12%	24%
KCF	749	796	97	11	12%	1%	13%
MBP	1,807	1,951	221	75	11%	4%	15%
MIPC	811	858	33	34	4%	4%	8%
MR	6,715	7,758	736	461	9%	6%	15%
MTU	5,129	6,021	787	395	13%	7%	20%
MCF	1,776	2,073	239	175	12%	8%	20%
Phoenix	836	926	91	78	10%	8%	18%
RCF	2,139	2,465	232	334	9%	14%	23%
SPSM	8,968	10,196	1,289	605	13%	6%	19%
TOTAL	45,175	51,340	4,837	3,459	9%	7%	16%

*Percentages are rounded off to the nearest percentile

**"Total % Not Guilty and Dismissed" represents the addition of the rounded off not guilty and dismissal percentages.

INSTITUTION	- 20	20-24	25-29	30-34	35-39	40-44	45-49	50-54	55-59	60-64	65-69	70-74	75-79	80 +	Med Age	Avg Age	Count
Riverside Recpt Ctr	55	35													19.8	19.5	90
Percentages	61.1	38.9															
Male Resident Homes	20	126	101	62	33	15	7	5	2						26.4	28.4	371
Percentages	5.4	34.0	27.2	16.7	8.9	4.0	1.9	1.3	0.5								
Cassidy Lake Tech	58	135	30	25	7	4			1						21.1	23.6	260
Percentages	22.3	51.9	11.5	9.6	2.7	1.5			0.4								
Huron Valley Women	14	54	114	100	56	22	10	1	2	1					30.3	30.8	374
Percentages	3.7	14.4	30.5	26.7	15.0	5.9	2.7	0.3	0.5	0.3							
Female Corr Centers		16	23	27	16	8	3	2	1						31.8	32.2	96
Percentages		16.7	24.0	28.1	16.7	8.3	3.1	2.1	1.0								
Female Res Homes	1	7	17	19	5	4	2	1							31.9	31.8	56
Percentages	1.8	12.5	30.4	33.9	8.9	7.1	3.6	1.8									
Mental Health Fac		17	29	16	3	9	5	5	2	5					29.8	34.1	91
Percentages		18.7	31.9	17.6	3.3	9.9	5.5	5.5	2.2	5.5							
Ionia Reformatory	203	754	178	28	5	1	1	1	2	1					22.0	22.8	1,174
Percentages	17.3	64.2	15.2	2.4	0.4	0.1	0.1	0.1	0.2	0.1							
SPSM	1	573	1144	1247	817	449	250	119	78	40	15	3	2		32.4	34.0	4,738
Percentages	0.0	12.1	24.1	26.3	17.2	9.5	5.3	2.5	1.6	0.8	0.3	0.1	0.0				
Muskegon Corr Fac	1	130	202	149	60	28	7	5	3	1	1				29.0	30.2	587
Percentages	0.2	22.1	34.4	25.4	10.2	4.8	1.2	0.9	0.5	0.2	0.2						
Phoenix Corr Fac	17	97	85	70	36	9	6	3	2	1					27.9	29.0	326
Percentages	5.2	29.8	26.1	21.5	11.0	2.8	1.8	0.9	0.6	0.3							
Marquette Branch Fac	5	111	230	174	103	44	17	13	7	2	3	1	1		30.3	31.9	711
Percentages	0.7	15.6	32.3	24.5	14.5	6.2	2.4	1.8	1.0	0.3	0.4	0.1	0.1				
Riverside Corr Fac	43	115	97	87	37	25	20	27	31	30	14	3	2	2	30.5	35.2	533
Percentages	8.1	21.6	18.2	16.3	6.9	4.7	3.8	5.1	5.8	5.6	2.6	0.6	0.4	0.4			
Kinross Corr Fac	2	144	238	199	107	52	26	16	6	3	2		1		30.3	31.8	796
Percentages	0.3	18.1	29.9	25.0	13.4	6.5	3.3	2.0	0.8	0.4	0.3		0.1				
Female Camps	4	15	47	38	28	17	5	2							31.3	32.4	156
Percentages	2.6	9.6	30.1	24.4	17.9	10.9	3.2	1.3									
MIPC	5	30	31	11	2		2		1						25.7	26.7	82
Percentages	6.1	36.6	37.8	13.4	2.4		2.4		1.2								
SPSM Reception Ctr	2	105	116	99	52	11	10	3	2	2	1				28.9	30.1	403
Percentages	0.5	26.1	28.8	24.6	12.9	2.7	2.5	0.7	0.5	0.5	0.2						
Mich Training Unit	258	496	18	2	1	1		1							20.7	20.9	777
Percentages	33.2	63.8	2.3	0.3	0.1	0.1		0.1									
Upper Male Camps	4	121	135	89	46	20	6	2	2	1					27.8	29.3	426
Percentages	0.9	28.4	31.7	20.9	10.8	4.7	1.4	0.5	0.5	0.2							
Huron Valley Mens	2	43	114	130	53	23	8	2	2	1					31.0	31.8	378
Percentages	0.5	11.4	30.2	34.4	14.0	6.1	2.1	0.5	0.5	0.3							
Lower Male Camps	10	174	271	273	127	49	15	4	5	1					30.0	30.7	929
Percentages	1.1	18.7	29.2	29.4	13.7	5.3	1.6	0.4	0.5	0.1							
Dunes Corr Facility	5	127	109	56	16	8	3	1	1						26.4	27.7	326
Percentages	1.5	39.0	33.4	17.2	4.9	2.5	0.9	0.3	0.3								
Male Corr Centers	65	245	245	183	96	34	19	6	4		1				27.8	28.8	898
Percentages	7.2	27.3	27.3	20.4	10.7	3.8	2.1	0.7	0.4		0.1						
Non-Dept Prisons		4	22	13	11	5	3		1	1					32.2	33.4	60
Percentages		6.7	36.7	21.7	18.3	8.3	5.0		1.7	1.7							
TOTAL	5.3	25.1	24.6	21.2	11.7	5.7	2.9	1.5	1.1	0.6	0.3	0.0	0.0	0.0	28.9	30.4	14,638

PAROLE

The D charts show parole activity in 1984. Table D1 counts the last continuance or parole action taken on a person during the year. A person may have had several actions during the year. In 1984, 56% of all first offenders were paroled on their minimums.

The Total Dispositions per category shows that 6,405 first offenders were considered for parole in 1984. Of those, 1,825 or 56% were paroled on their minimum; 44% or 1,418 were paroled after their minimums.

Of the 2,133 parole violators with new sentences considered, 699 or 33% were paroled. Of the 2,133 considered, 41% or 286 were paroled on their minimums.

A total of 4,678 repeat offenders were considered by the Board in 1984. A total of 39% or 675 of the 4,678 considered were paroled on their minimums. A total of 37% of these types of offenders were paroled.

A total of 6,127 persons from all categories were paroled in 1984; a total of 3,672 were continued. The parole to continuance ratio is, therefore, 2 to 1.

D1a shows the number and location of parole hearings in 1984.

The D2a and D2b charts show the results of four-year follow-ups of persons paroled in 1980. The offense groups shown on the left in D2a are those crimes from which the prisoner was paroled.

A new chart makes its premier in the 1984 annual report. It shows the crimes for which paroles were returned and compares them with the crime from which the person was paroled.

The table counts the original crime -- see column labeled "ORIG TOTL" --and contains subtotal counts for the group category of these crimes.

The table counts the crimes committed while on parole (P.V.N.S.).

To use the chart, find the crime title in the vertical column on the left.

Following the title will be an alpha character in parentheses. For example, homicide has the alpha character (A). The number beside this character (13) shows the number of people paroled in 1980 from a homicide and who were later returned for a new crime. Next, locate the character (A) across the top of the chart. (A) represents the crime of homicide and shows how many of the 13 persons were returned to prison for the crime of homicide. Looking below A, you can see that one person of the 13 came back with a crime of homicide. By moving to the next vertical column (B) you can see how many people paroled from homicide (A) were returned with a sentence of rape (B). In this case there were none.

+ + +

DI PAROLE BOARD ACTION - FOR FULL YEAR 1984
DISPOSITIONS RECORDED FROM HEARING & EXECUTIVE SESSIONS

Case Category	Total Dispositions Per Category	Paroled on Minimum	Paroled Prior to Min		Paroled After Minimum	Total Paroled Per Category	Continued
			Special	90 - Day			
First Offenders	6405	1825 56%	6 100%	1 100%	1418 44%	3250 51%	1097 17%
Min Expiration Cases	2588	1383	6	1	0	1390	91
Continued Previously	1448	0	0	0	489	489	207
Deferred Previously	2369	442	0	0	929	1371	799
Parole Violators (new sentence)	2133	286 41%	2 100%	0 00%	411 59%	699 33%	649 30%
Min Expiration Cases	623	187	2	0	0	189	86
Continued Previously	681	0	0	0	196	196	92
Deferred Previously	829	99	0	0	215	314	471
Repeated Offenders	4678	675 39%	1 100%	1 100%	1068 61%	1745 37%	1186 25%
Min Expiration Cases	1523	456	1	1	0	458	137
Continued Previously	1326	0	0	0	421	421	188
Deferred Previously	1829	219	0	0	647	866	861
Technical Violators	305	6 03%			216 97%	222 73%	27 09%
Continued Previously	233	0			176	176	8
Deferred Previously	72	6			40	46	19
Returned Technical Violators (Initial Hearings)	983	0 00%			198 100%	198 20%	709 72%
Long Indeterminate Sent.	11	1 33%	0 00%	0 00%	2 67%	3 27%	4 36%
Lifer Laws	7				7	7	
Murder First	3				3	3	
GRAND TOTAL DISPOSITIONS	14,525	2,793 46%	9 100%	2 100%	3,323 54%	6,127	3,672

PAROLE BOARD ACTION - FOR FULL YEAR 1984
PLACE OF HEARING

Cassidy Lake	87	Marquette	292
Huron Val Wn Fac	254	M.I.P.C.	38
Huron Val Men Fac	152	Michigan Training Unit	434
Riverside Recpt Center	3	Lower Camps	353
Recpt Guid Center	0	Upper Camps	227
Phoenix Corr Facility	563	Camp Gillman	97
Kinross Corr Facility	355	Male Corr Center	328
Michigan Reformatory	579	Female Corr Center	31
Jackson	2776	Male Resident Home	136
Muskegon Corr Facility	344	Female Resident Home	11
Riverside Corr Fac	270	County Jails	8
Dunes Corr Facility	198	Mental Health Hosp	16
Client didn't show	1	Fed & Dth State Pris	3
		TOTAL HEARINGS:	7556
		Office Decisions:	9668
		Executive Sessions:	757
		TOTAL	17,981

GRAND TOTAL - PAROLE BOARD ACTIONS: 17,981

D2a FOLLOW-UP STUDY OF FIRST PAROLE FOR 1980 BY OFFENSE GROUPS

Offense Groups (1)	SUCCESSSES		FAILURES			BY PERCENT TO TOTAL			
	Total Cases	Total	Total	Tech Viol	PVNS	Total Succ.	Total Fail.	Tech Viol	PVNS
TOTAL OF ALL CASES	4,193	2,872	1,321	642	679	68.5	31.5	15.3	16.2
Offenses Against Persons	1,578	1,155	423	210	213	73.2	26.8	13.3	13.5
Homicide	222	194	28	15	13	87.4	12.6	6.8	5.9
Rape	214	171	43	23	20	79.9	20.1	10.7	9.3
Abduction - Kidnapping	8	7	1	1	0	87.5	12.5	12.5	0.0
Assault	458	315	143	75	68	68.8	31.2	16.4	14.8
Robbery	663	458	205	95	110	69.1	30.9	14.3	16.6
Offenses Against Children	5	5	0	0	0	100.0	0.0	0.0	0.0
Sex	8	5	3	1	2	62.5	37.5	12.5	25.0
Property Offenses	1,823	1,165	658	308	350	63.9	36.1	16.9	19.2
Arson	42	28	14	8	6	66.7	33.3	19.0	14.3
Burglary	707	434	273	106	167	61.4	38.6	15.0	23.6
Larceny	739	481	258	132	126	65.1	34.9	17.9	17.1
Auto Theft	87	58	29	13	16	66.7	33.3	14.9	18.4
Forgery, Uttering & Pub.	159	95	64	34	30	59.7	40.3	21.4	18.9
Embezzlement	14	13	1	1	0	92.9	7.1	7.1	0.0
Fraud	55	40	15	11	4	72.7	27.3	20.0	7.3
Malicious Destruction	20	16	4	3	1	80.0	20.0	15.0	5.0
All Other Offenses	792	552	240	124	116	69.7	30.3	15.7	14.6
Drugs	414	321	93	50	43	77.5	22.5	12.1	10.4
Weapons	126	85	41	18	23	67.5	32.5	14.3	18.3
Prostitution	3	3	0	0	0	100.0	0.0	0.0	0.0
Desertion & Non-Support	0	0	0	0	0	0.0	0.0	0.0	0.0
Gambling	0	0	0	0	0	0.0	0.0	0.0	0.0
Interfere W/Legal Processes	191	97	94	50	44	50.8	49.2	26.2	23.0
Miscellaneous	51	41	10	5	5	80.4	19.6	9.8	9.8
Motor Vehicle	7	5	2	1	1	71.4	28.6	14.3	14.3

Number of Deaths on Parole: 45
 Not Reported: 0
 Total Cases: 4,193

(1) Refers to the sentence from which the individual is paroled.

D2b Follow-Up Study of First Paroles for 1980

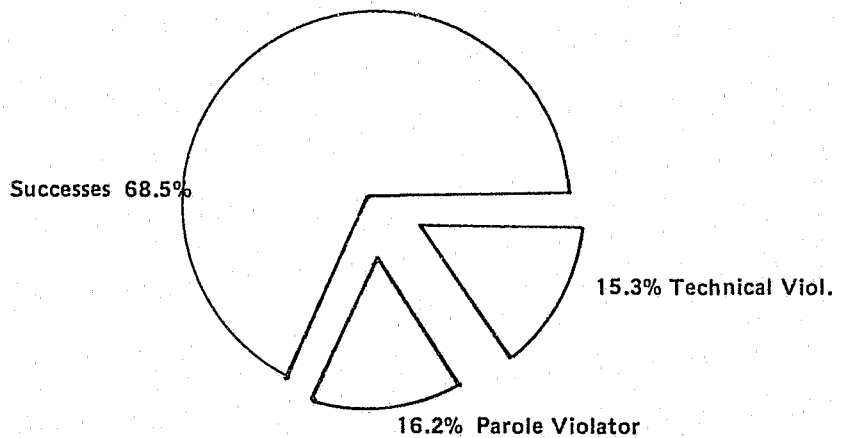

D2C 1980 PAROLES RETURNED: Original Crime Type vs. New Crime Type

Crime Description	Orig Totl	New Offn Ag/P	(A)	(B)	(C)	(D)	(E)	(F)	(G)	NEW PROP OFFN	(H)	(I)	(J)	(K)	(L)	(M)	(N)	(O)	OTHR OFEN	(P)	(Q)	(R)	(S)	(T)	(U)	(V)	(W)
TOTAL CASES	679*	203	20	0	5	41	103	1	33	398	0	183	164	14	21	1	10	5	74	36	30	0	0	0	0	8	0
OFF/AG/PERSN	213	102	11	0	2	18	54	0	17	84	0	41	37	1	3	0	1	1	24	9	13	0	0	0	0	2	0
Homicide (A)	13	6	1	0	0	1	4	0	0	4	0	0	4	0	0	0	0	0	3	1	2	0	0	0	0	0	0
Rape (B)	20	15	0	0	0	3	3	0	9	5	0	3	2	0	0	0	0	0	0	0	0	0	0	0	0	0	0
Abduct/k (C)	0	0	0	0	0	0	0	0	0	0	0	0	0	0	0	0	0	0	0	0	0	0	0	0	0	0	0
Assault (D)	68	37	6	0	2	9	15	0	5	25	0	12	9	1	2	0	0	1	6	3	3	0	0	0	0	0	0
Robbery (E)	110	43	4	0	0	5	32	0	2	49	0	26	21	0	1	0	1	0	15	5	8	0	0	0	0	2	0
Offenses (F)																											
Agst/Cld	0	0	0	0	0	0	0	0	0	0	0	0	0	0	0	0	0	0	0	0	0	0	0	0	0	0	0
Sex (G)	2	1	0	0	0	0	0	0	1	1	0	0	1	0	0	0	0	0	0	0	0	0	0	0	0	0	0
PROPERTY/OFN	350	65	2	0	3	14	36	0	10	256	0	118	104	10	13	0	7	4	29	15	9	0	0	0	0	5	0
Arson (H)	6	3	0	0	0	1	2	0	0	1	0	1	0	0	0	0	0	0	2	1	0	0	0	0	0	1	0
Burglary (I)	167	27	1	0	1	5	14	0	6	131	0	72	42	2	7	0	5	3	9	5	4	0	0	0	0	0	0
Larceny (J)	126	23	1	0	1	5	13	0	3	89	0	32	49	6	0	0	1	1	14	8	2	0	0	0	0	4	0
Autotheft (K)	16	6	0	0	0	1	5	0	0	10	0	4	4	1	1	0	0	0	0	0	0	0	0	0	0	0	0
Forg/Utr/ (L)																											
Publish	30	5	0	0	1	1	2	0	1	21	0	9	6	1	4	0	1	0	4	1	3	0	0	0	0	0	0
Embelzmt (M)	0	0	0	0	0	0	0	0	0	0	0	0	0	0	0	0	0	0	0	0	0	0	0	0	0	0	0
Fraud (N)	4	1	0	0	0	1	0	0	0	3	0	0	2	0	1	0	0	0	0	0	0	0	0	0	0	0	0
Malc/Dst (O)	1	0	0	0	0	0	0	0	0	1	0	0	1	0	0	0	0	0	0	0	0	0	0	0	0	0	0
OTHER OFFENS	116	36	7	0	0	9	13	1	6	58	0	24	23	3	5	1	2	0	21	12	8	0	0	0	0	1	0
Drugs (P)	43	13	4	0	0	3	4	0	2	15	0	7	5	0	2	1	0	0	14	11	2	0	0	0	0	1	0
Weapons (Q)	23	14	2	0	0	4	6	1	1	5	0	2	1	0	1	0	1	0	4	0	4	0	0	0	0	0	0
Prostitu (R)	0	0	0	0	0	0	0	0	0	0	0	0	0	0	0	0	0	0	0	0	0	0	0	0	0	0	0
Desertion (S)																											
Non-Supt	0	0	0	0	0	0	0	0	0	0	0	0	0	0	0	0	0	0	0	0	0	0	0	0	0	0	0
Gambling (T)	0	0	0	0	0	0	0	0	0	0	0	0	0	0	0	0	0	0	0	0	0	0	0	0	0	0	0
Interfere/(U)																											
Legal-Pr	44	8	1	0	0	2	3	0	2	33	0	13	16	2	2	0	0	0	3	1	2	0	0	0	0	0	0
Misc. (V)	5	1	0	0	0	0	0	0	1	4	0	1	1	1	0	0	1	0	0	0	0	0	0	0	0	0	0
Motor/Vh (W)	1	0	0	0	0	0	0	0	0	1	0	1	0	0	0	0	0	0	0	0	0	0	0	0	0	0	0

* New Offense Type Unknown for 4 Cases.

56

FIELD SERVICES

This section describes, through use of statistics, the activities of the Bureau of Field Services.

This bureau supervises all felons on probation, parole or living in the community in a halfway house or resident home.

The supervision is divided into three regions which are shown on the map in this section.

The central office prepares budgets, sets policies and handles matters that cannot be taken care of locally such as the Interstate Compact and communications concerning absconders picked up in other states.

Parole violations which result in return to prison are shown in this section.

Personnel and funds distribution illustrate the total staff in field supervision, community corrections centers and central office administration. It also describes, through a pie chart, the dollars spent during the 1983-84 fiscal year on these same bureau sections. The work unit distribution charts show how the work time of the employees of this bureau is divided into supervision and investigation.

Supervision is further divided into type and shows the probation supervision accounts for 68.6 percent of all supervision activities.

Investigation accounts for 27.2 percent of the work units. Of all investigations, those done for the pre-sentence reports clearly predominate.

The bureau measures workloads by assigning unit values to the various tasks. A completed pre-sentence investigation equals five units and each client supervised ranges from 2 units to .1 unit. In most Michigan counties parole and probation agents average 110 work units per month.

This section also contains charts illustrating the activities of the Community Alternatives Program.

+ + +

MAP

Bureau of Field Services Regions and Districts as of Dec. 31, 1984.

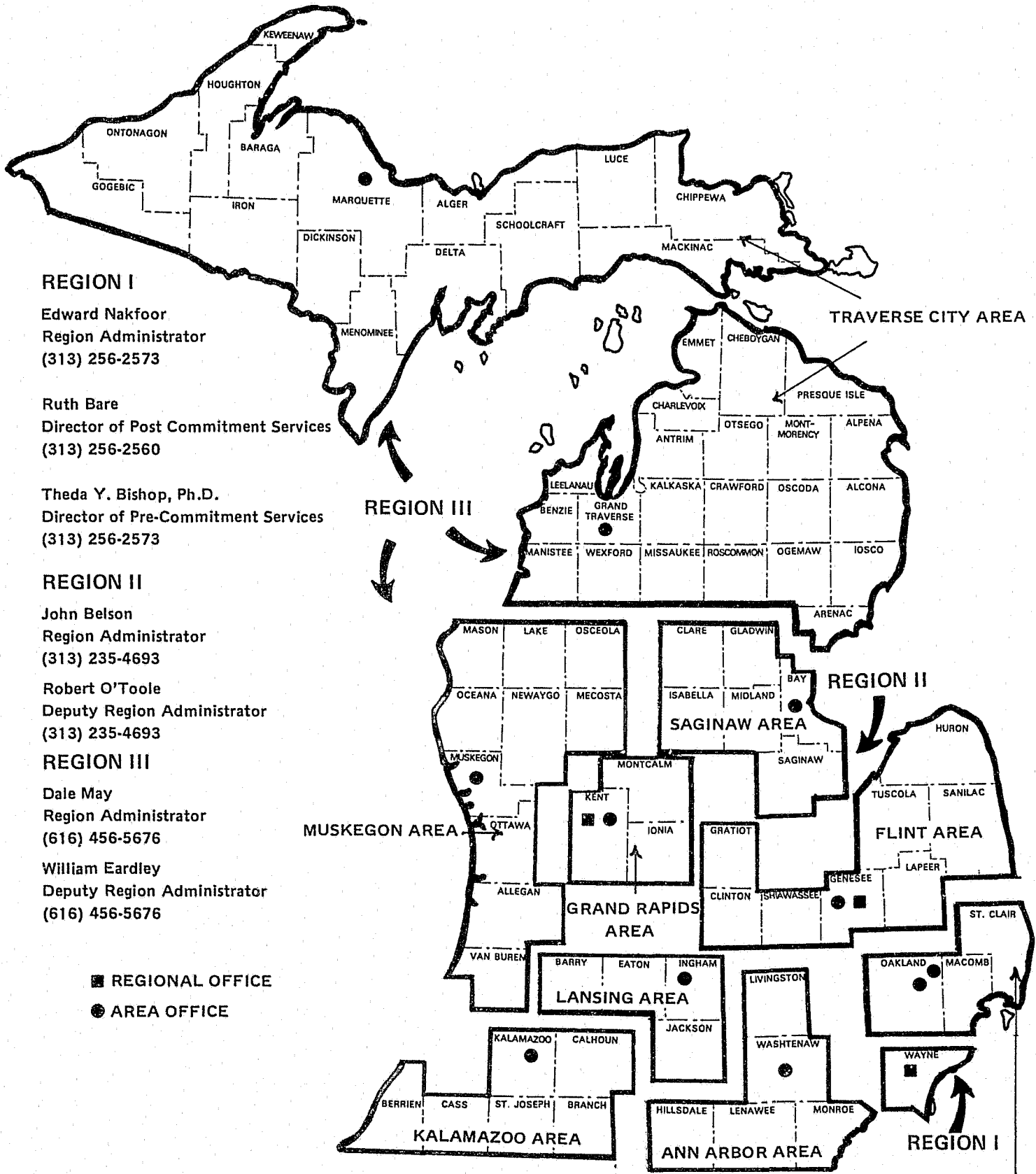

*Oakland Area - Probation Only
 Mt. Clemens Areas - All Functions/Macomb-
 St. Clair, CRP/
 Parole only - Oakland

OAKLAND & MT. CLEMENS AREA

E1 Parole Violations

TECHNICAL RETURNS (Includes Out-of-State Returns)

Date	Male	Female	Total
1980	446	15	461
1981	471	24	495
1982	491	21	512
1983	547	28	575
1984	806	36	842

PVNS RETURNS

Date	Male	Female	Total
1980	630	20	650
1981	633	23	656
1982	674	26	700
1983	796	49	845
1984	915	56	971

PAROLE REVOCATION HEARINGS

1980	114
1981	99
1982	123
1983	109
1984	147

Personnel and Funds Distribution

Personnel (Organization)

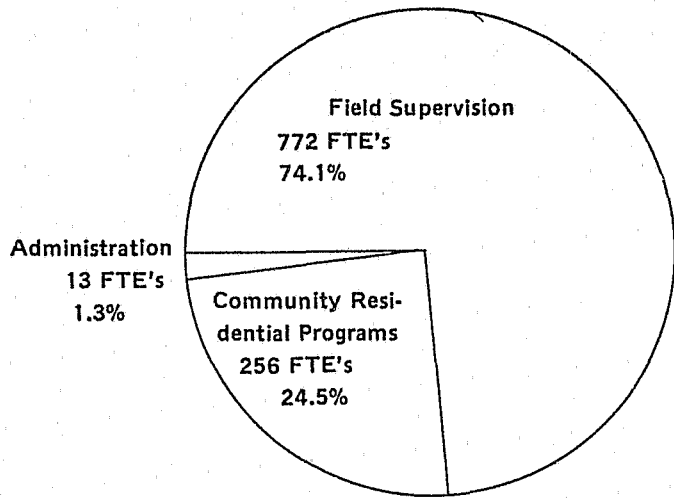

Personnel (Distribution) Category

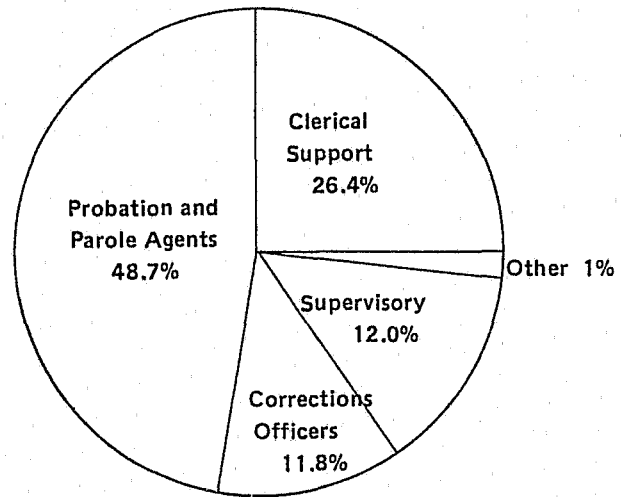

Funds

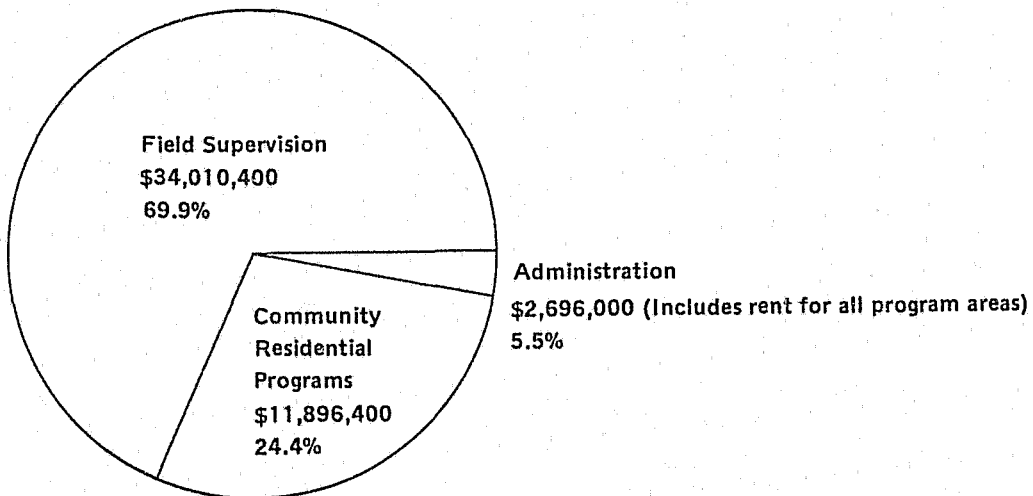

E3 WORK UNIT DISTRIBUTION: Total Work Units, 52,113*

Work Units are a unit value assigned to a particular function or task. Figure does not include Community Residential Programs.

INVESTIGATIONS: 14,169 Units; 27.18% of Total

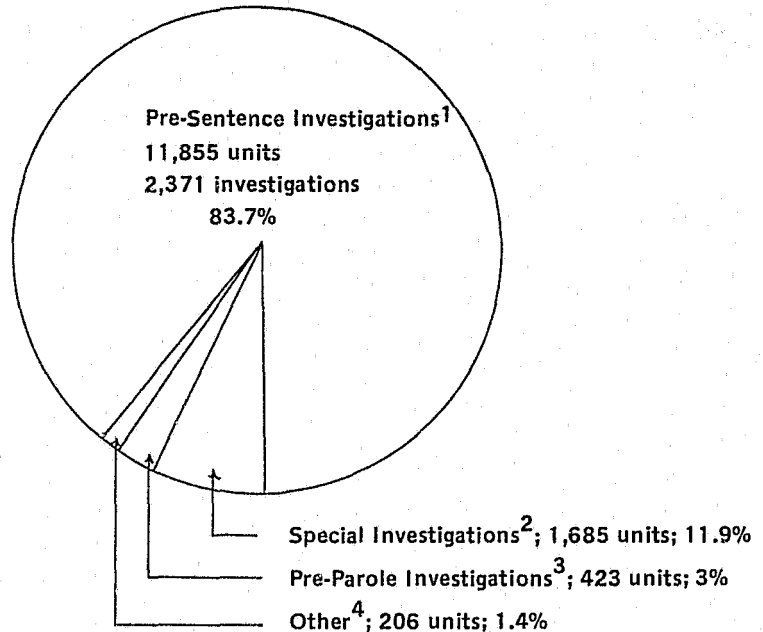

1. **PRE-SENTENCE INVESTIGATIONS:** indepth analysis of the individual and circumstances of the offense.
2. **SPECIAL INVESTIGATIONS:** reports done at the request of the Governor, other States and the Parole Board.
3. **PRE-PAROLE INVESTIGATIONS:** prior to inmate release, living arrangements and job placement are investigated.
4. **OTHER:** investigations done for community residential programs.

SUPERVISION: 37,944 Units; 72.82%
 Clients Supervised: 39,423

OTHER: 362 cases, .9%

DELAYED SENTENCE: 485 cases, 2.10%

**HOLMES YOUTHFUL TRAINEE:
 1,915 cases
 4.90%**

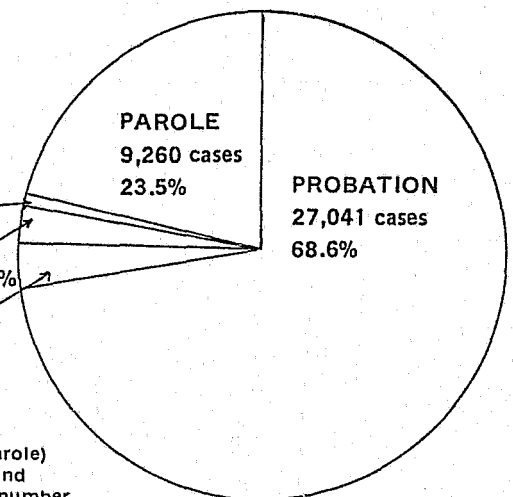

Supervision is the process in which parole or probation agents work with clients while under the jurisdiction of the Department of Corrections (parole) or the jurisdiction of the Courts (probation, Holmes Youthful Trainee, and delayed sentences). The case numbers in the chart represent the average number of cases under supervision during the year.

*All Figures represent monthly average

E4a

PROBATION TERMINATIONS*

Year	Total Probation Terminations	Successful			Total Unsuccessful	Unsuccessful						Average Months Supervised	Deaths	
		Total Success	Average Percent Success	Months Supervised		Discharge		Technical P.V.		New Felony			Total Deaths	Percent Dead
						Total Dischar.	Percent Dischar.	Total Tech P. V.	Percent Tech P. V.	Total New Felons	Percent New Felons			
1979	8,645	6,870	79%	23	1,754	476	6%	920	11%	358	4%	18	21	-
1980	8,966	7,034	78%	23	1,865	534	6%	906	10%	425	5%	17	67	1%
1981	7,764	5,965	77%	24	1,732	420	5%	948	12%	364	5%	18	67	1%
1982	8,093	6,193	77%	24	1,840	423	5%	994	12%	423	5%	18	60	1%
1983	8,058	5,909	73%	24	2,055	406	5%	1,012	13%	637	8%	16	94	1%
1984	7,963	6,044	75%	23	1,919	382	5%	942	12%	595	7%	17	90	1%

* Data for years 1979-1982 excludes Wayne County; 1983 and after includes Wayne County

** 1983 and after data based on people and not cases, hence, the reduction in numbers

63

E4b

DISPOSITION OF PROBATION VIOLATIONS* 1980 - 1984

Year	Total Disposition	Prison		Probation		Jail		Other	
		Total Prison	Percent Prison	Total Probation	Percent Probation	Total Jail	Percent Jail	Total Other	Percent Other
1980	1,865	699	38%	94	5%	790	42%	282	15%
1981	1,726	595	35%	82	5%	782	45%	267	15%
1982	1,841	639	34%	70	4%	843	46%	289	16%
1983	2,055	728	35%	68	3%	820	40%	439	21%
1984	1,919	715	37%	48	3%	733	38%	423	22%

* Data for years 1980-82 excludes Wayne County; 1983 and after includes Wayne County

E5a Average Monthly Statewide Workunits* Annually

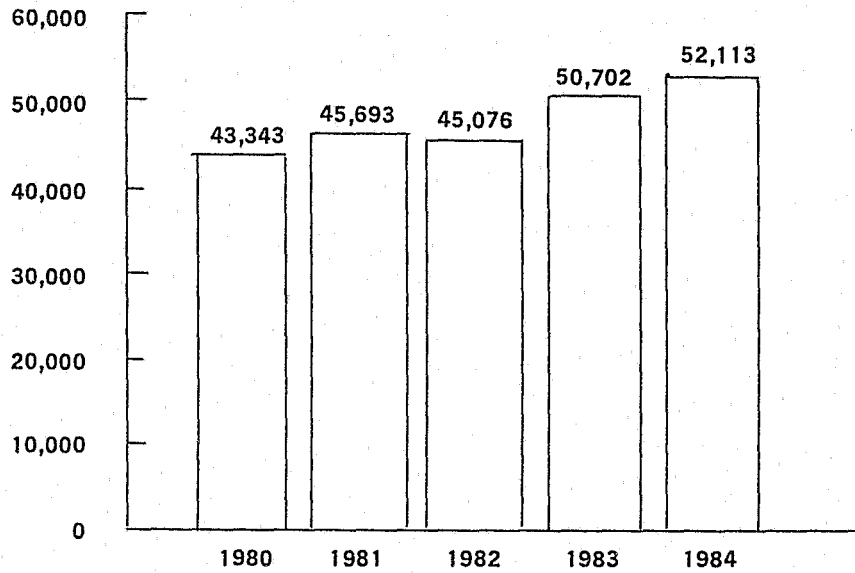

*NOTE: Workloads consist of a monthly compilation of work units weighted on the basis of the amount of time required to complete each activity such as pre-sentence investigation or a case supervision.

E5b Yearly Number of Pre-Sentence Investigations

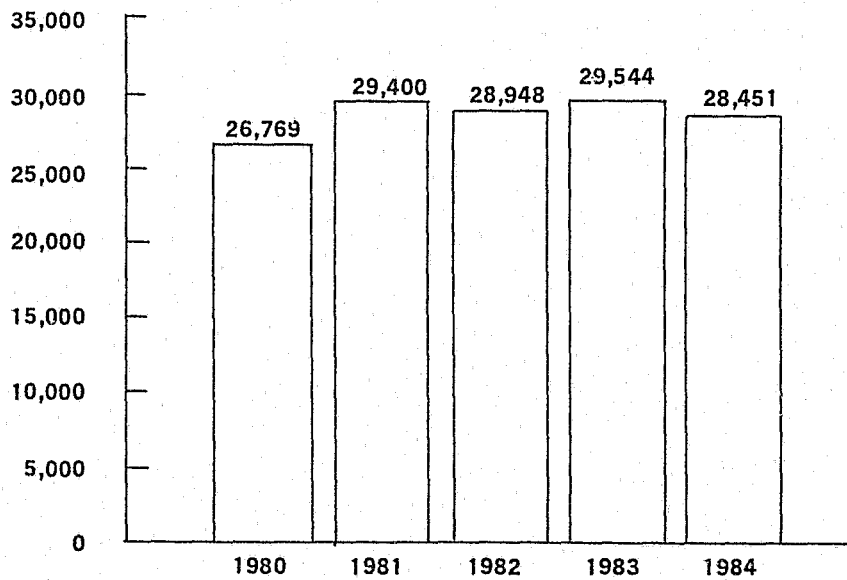

E6a Average Number of Parole Cases Supervised

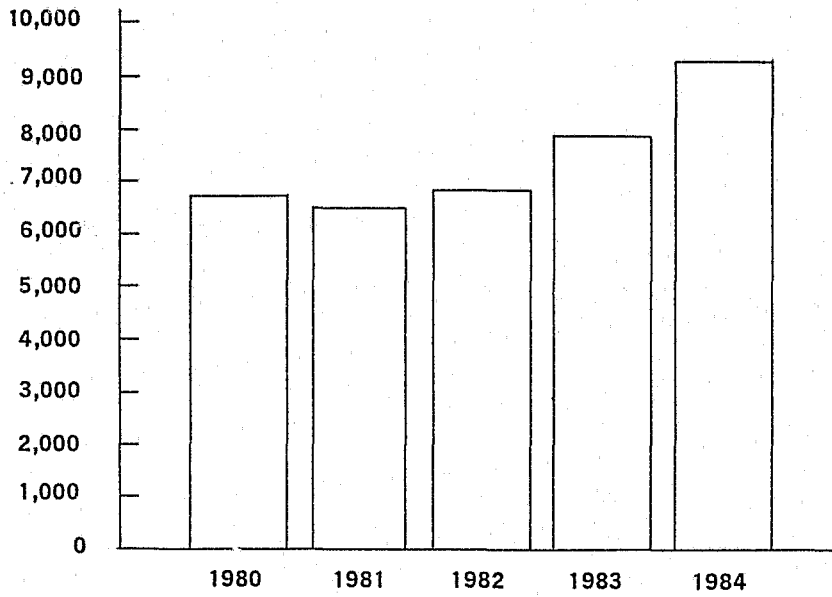

E6b Average Number of Probationers Under Supervision (includes Probation, Delayed Sentences and Holmes Youthful Trainees)

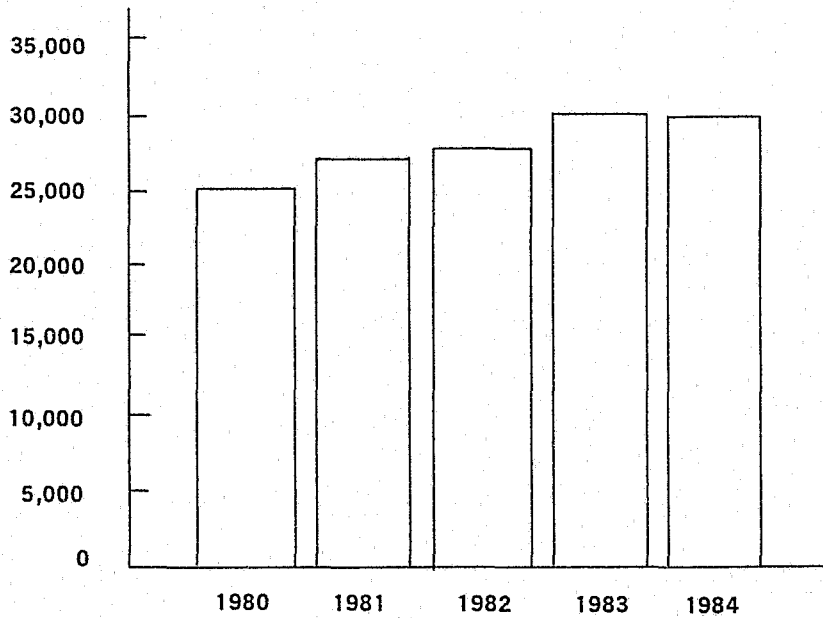

E7 Community Alternative Program Funding 1983-84 FY

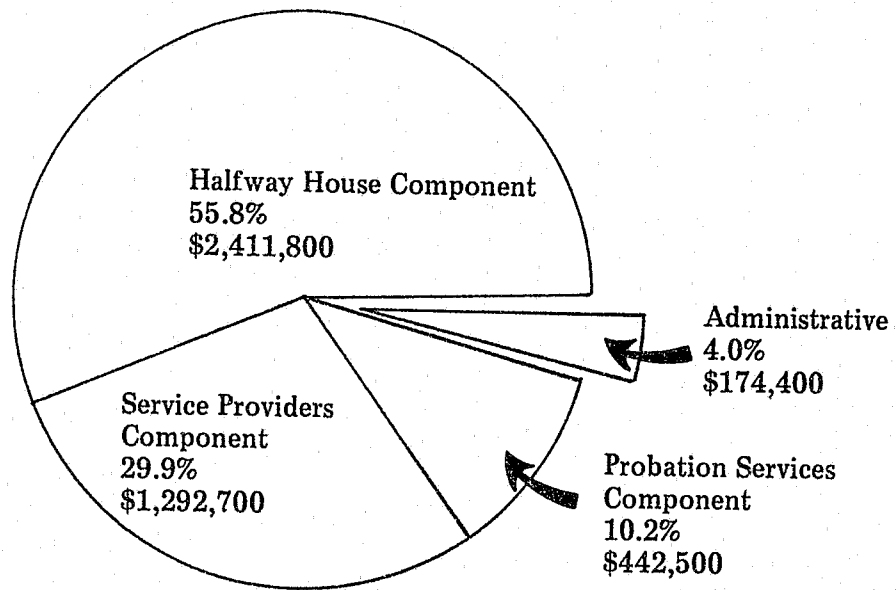

TOTAL 1983-84 FY BUDGET: \$4,321,500

E8

Community Alternative Programs Probation Halfway House

Average Daily Count
1984 - - - - -
1983 - - - - -

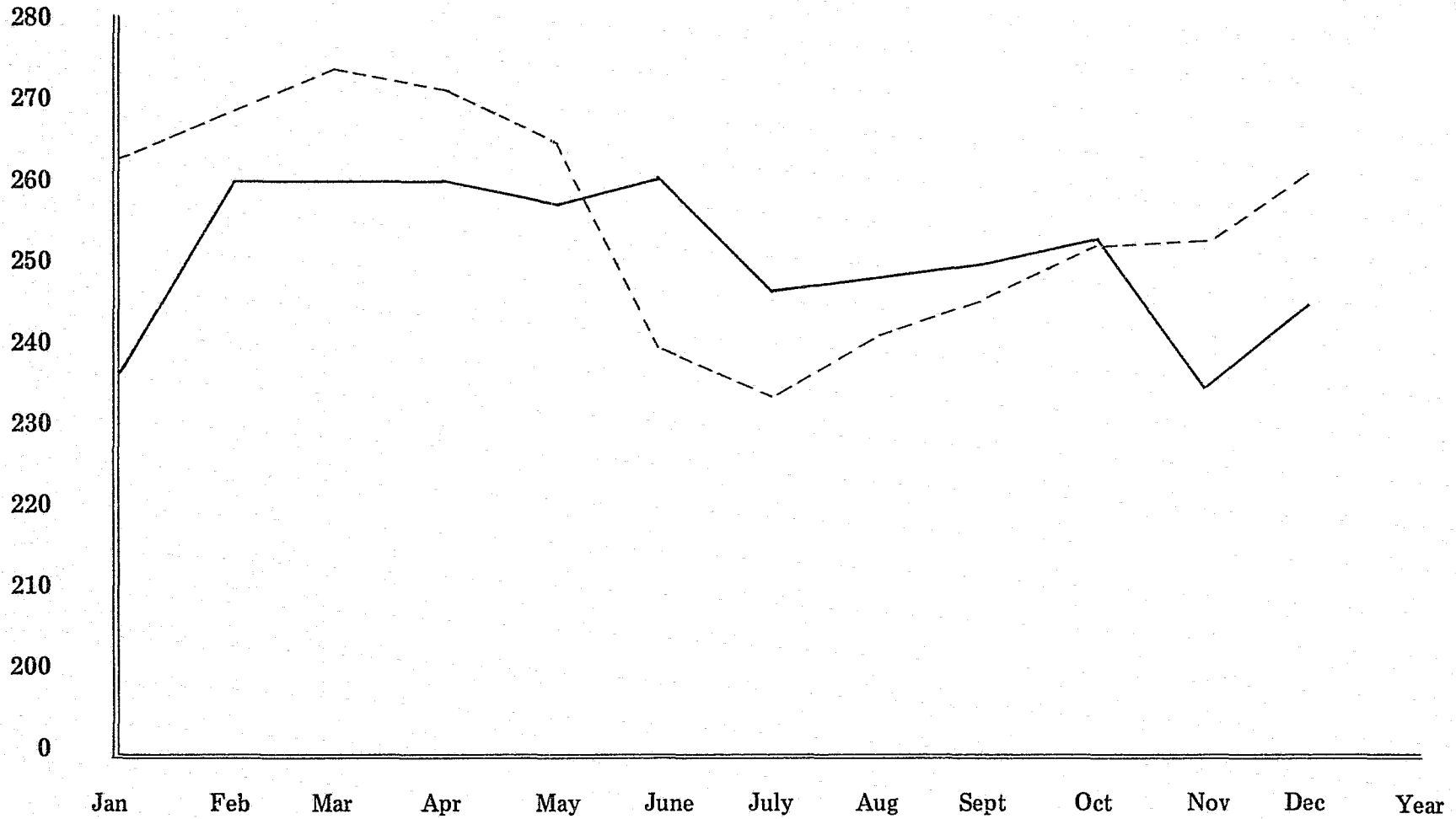

COMMUNITY CORRECTIONS

The F charts describe the department's halfway house program in 1984.

F-1 reflects community programs population, terminations, escapes, new felonies, earnings and cost statistics during a five-year period.

The average daily count was 1,587 and the service population 6,792 in the 1983-84 fiscal year. The average stay is 2.8 months. In 1984, 66.3% of all prisoners leaving the program were paroled; 5.5% were returned to prison because of disciplinary charges; 16.9% escaped; and 3.5% left with a new felony charge.

CRP Terminations - Percent of Total 1975-FY 1983-84 (F-6) -- shows general trends in termination statistics over the past 10 years.

+ + +

F1 COMMUNITY PROGRAMS STATISTICS: 1980 through 1983-84 Fiscal Year

	1983-84 FY	1982-83 FY	1982-81 FY	1981	1980
Beginning Count	1728	2114	2063	2128	1687
Additions	5064	4624	5227	5254	4470
Service Population	6792	6738	7290	7382	6157
Average Daily Count	1587.1	1761.9	1867.2	2073.6	1834.0
Average Stay (months)	2.80	3.14	3.08	3.37	3.58
Terminations	5299	5015	5128	5677	4029
Parole Discharge	3511	3129	2920	2997	2000
Percent	66.3	62.4	59.6	52.8	49.6
Disciplinary Return	294	306	395	665	597
Percent	5.5	6.1	7.7	11.7	14.8
Escape	897	944	1121	1364	999
Percent	16.9	18.8	21.9	24.0	24.8
New Felony Charge	187	222	361	530	307
Percent	3.5	4.4	7.0	9.3	7.6
Total Unsuccessful Terminations	1378	1472	1877	2559	1903
Percent	25.9	29.3	36.6	45.0	47.2
*Other	410	410	331	121	126
Percent	7.8	8.2	6.5	2.2	3.1
ENDING COUNT	1545	1738	2111	1705	2128
GROSS EARNINGS (millions)	\$3.22	3.32	4.06	5.48	5.91
Per Prisoner Earnings/Day	\$5.55	5.16	5.95	7.24	8.81
PER DIEM COST (F.Y.)	\$22.60	18.96	17.35	14.57	13.06
INSTITUTION COST (F.Y.)	\$42.85	37.69	30.70	25.40	21.79

*Medical, Psychiatric, Death, Court Order, Etc.

F2 CRP Program Terminations FY 1983-84

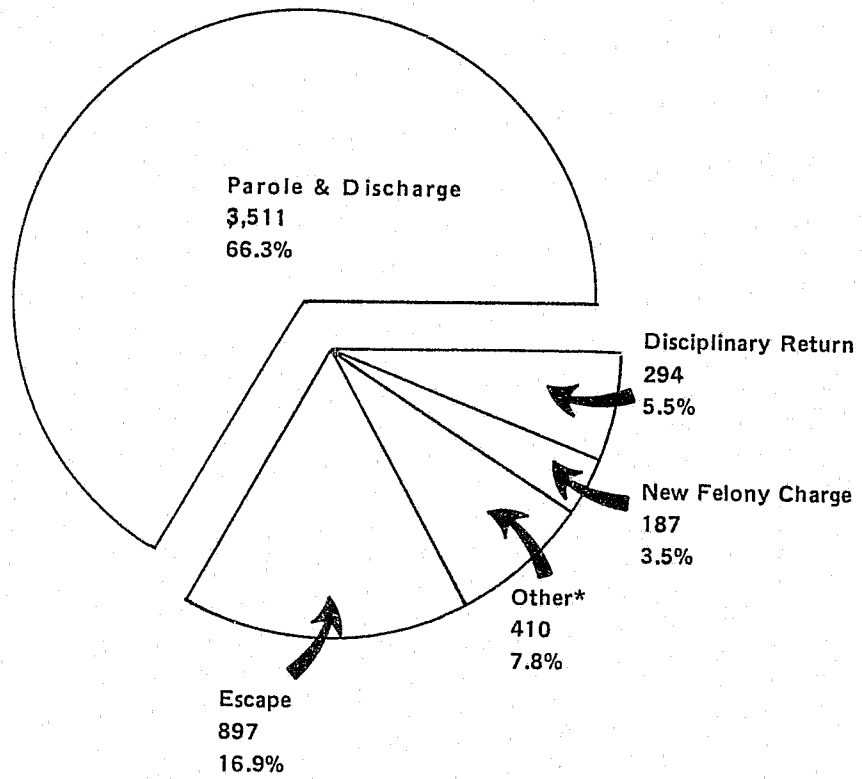

* Medical, Psychiatric, Death, Court Order

F3 Community Programs Population 1975 — FY 1983-84

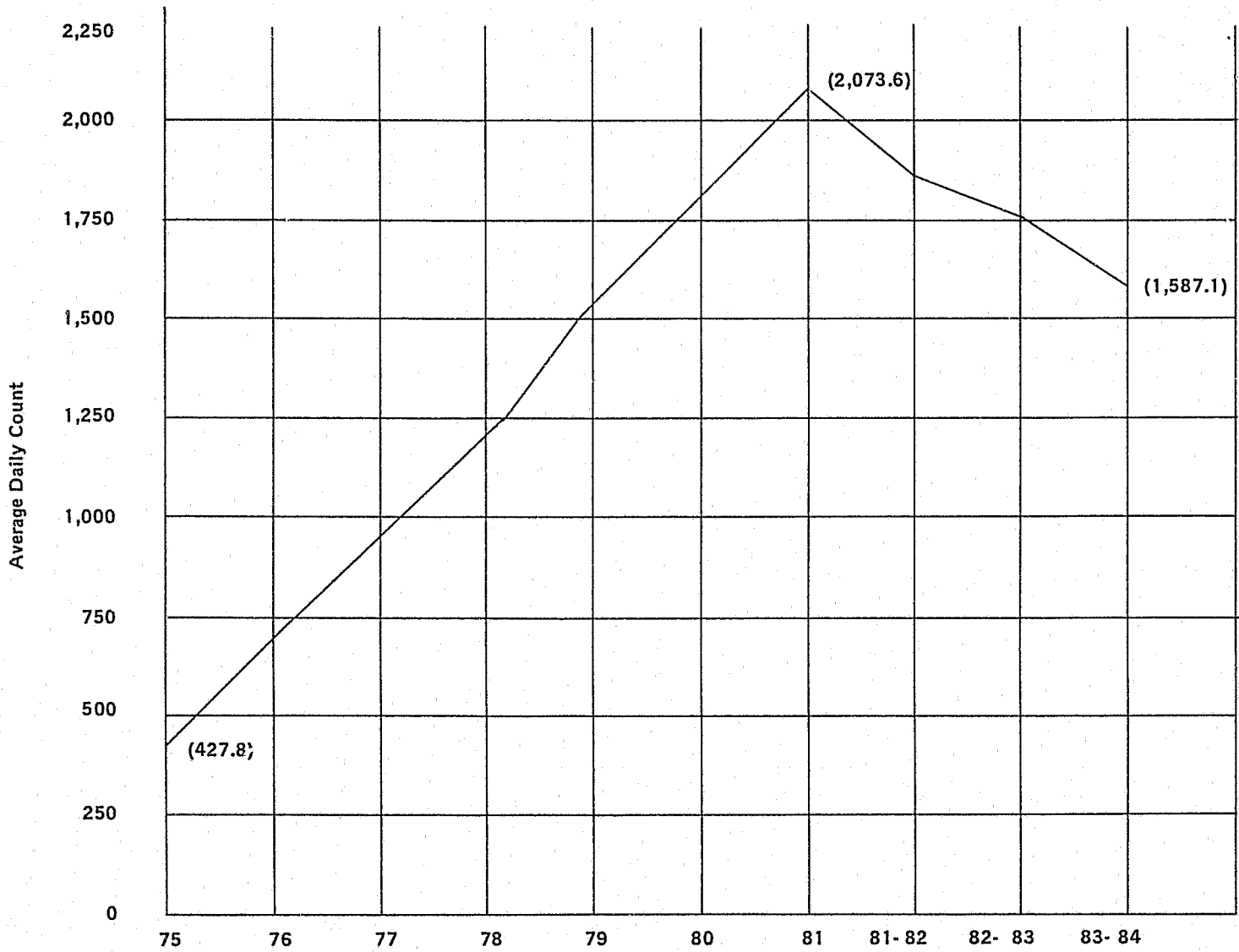

F4 CRP Prisoner Earnings Distribution FY 1983-84

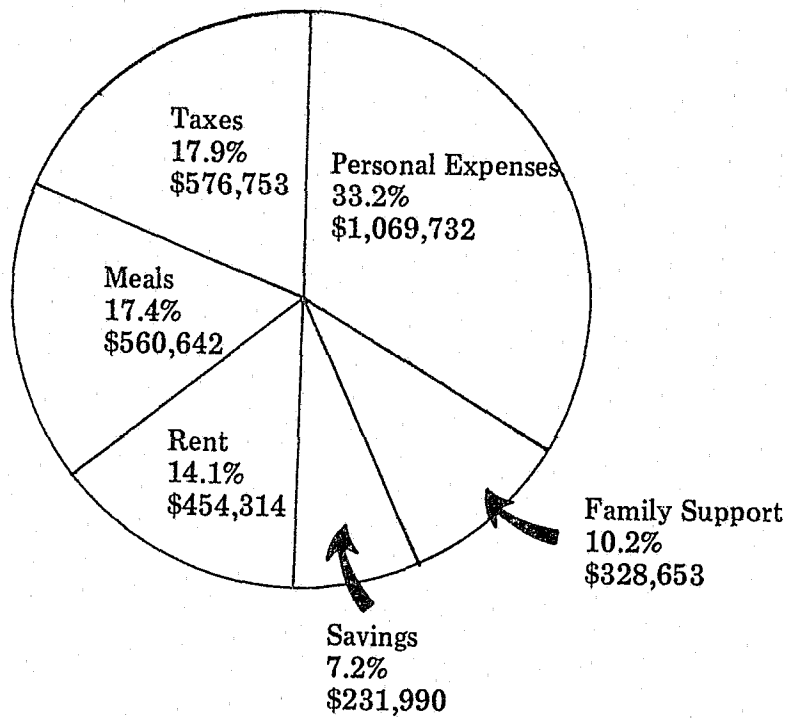

TOTAL GROSS EARNINGS: \$3,222,085

F5

Community Programs Prisoner Earnings 1978 - 1983-84

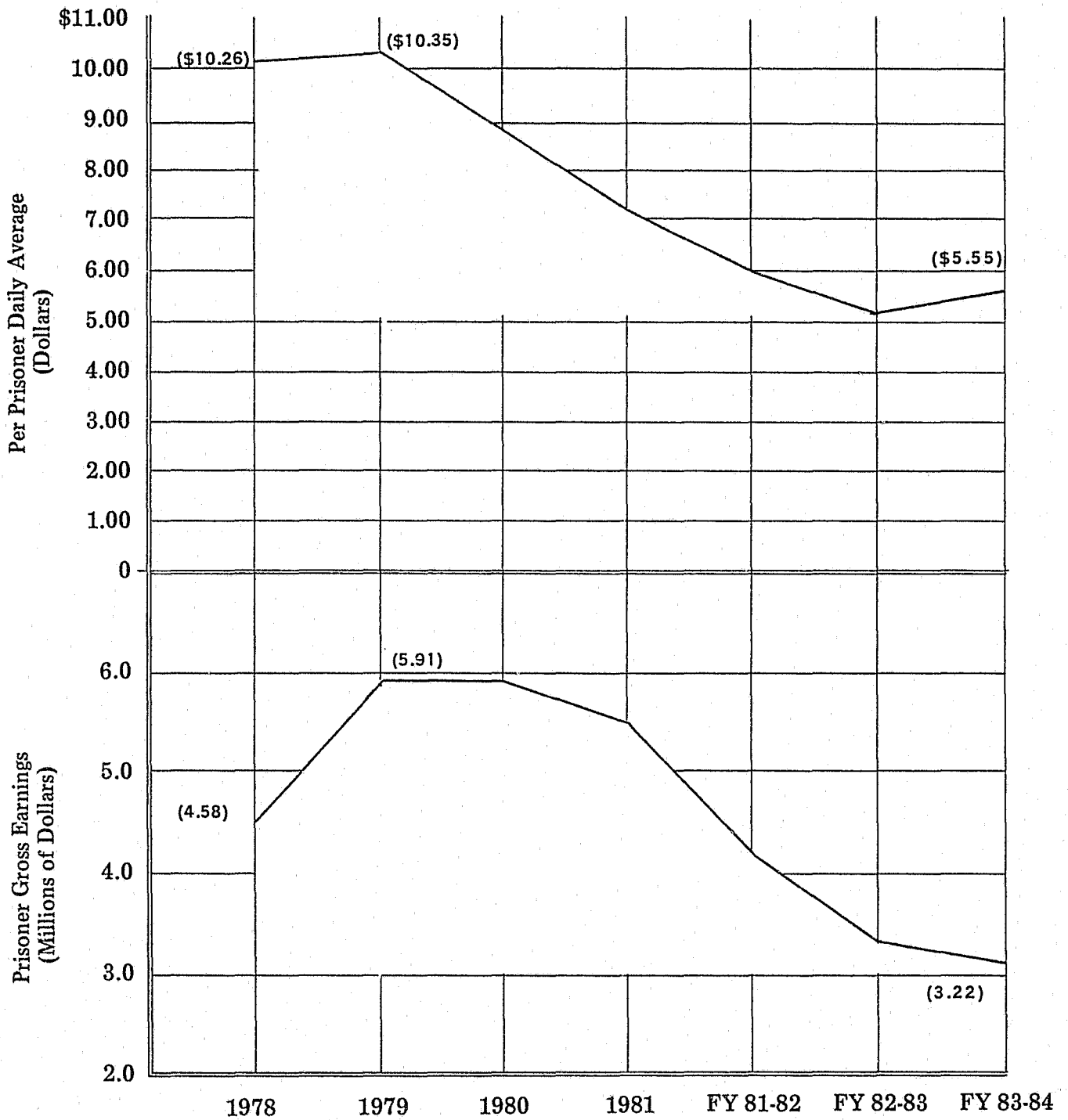

F6 CRP Terminations* Percent of Total 1975 - 1983-84

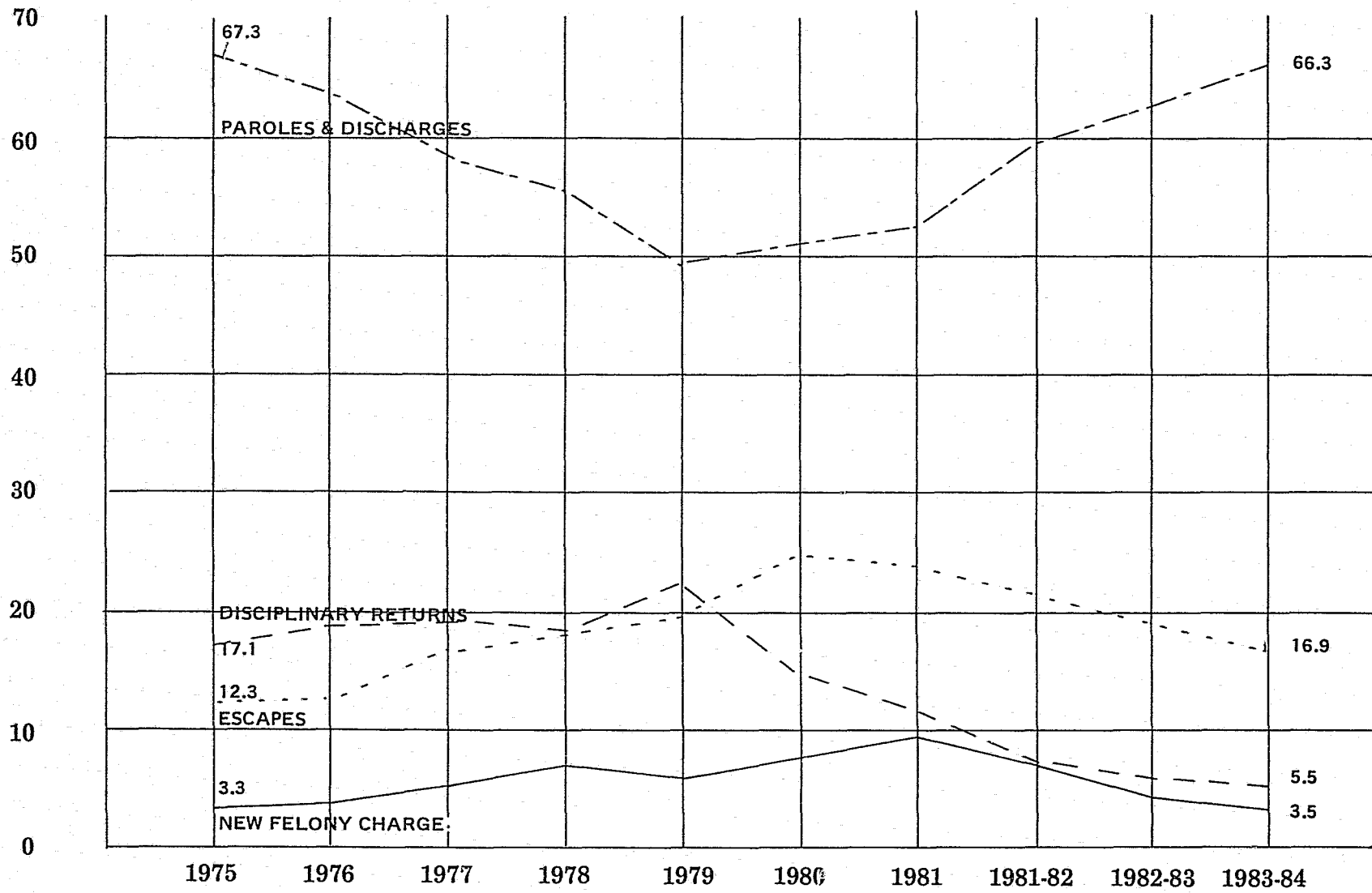

FINANCE

These charts show where the department spent its 1983-84 fiscal year budget.

GI shows expenditures by institutions, bureaus and other sections of the Department. G-2 shows budget expenditures in major categories such as salary and wages, CSS&M retirement.

+ + +

G1 ACTUAL EXPENDITURES AND ENCUMBERANCES / Excluding Riot & Capitol Outlay / 83-84

	%	Expenditures	Encumberance	Total
Central Office Administration	7.62	19,700,630.08	401,796.93	20,102,427.01
Prison Industries	1.50	3,934,299.96	0	3,934,299.96
Field Services Parole Supervision, CRP	16.30	42,914,170.66	38,576.83	42,952,747.49
Huron Valley Women's	2.45	6,404,836.02	38,584.04	6,443,420.06
Huron Valley Men's	3.72	9,794,695.80	256.47	9,794,952.27
Riverside Correc. Facility	4.67	12,248,618.74	51,527.53	12,300,146.27
Kinross Correc. Facility	4.29	11,280,242.27	14.77	11,280,257.04
Michigan Dunes	2.39	6,299,340.09	0	6,299,340.09
Phoenix Correc. Facility	2.34	6,138,694.24	23,594.85	6,162,289.09
SPSM	20.20	53,048,407.11	187,453.57	53,235,860.68
Marquette Branch Prison	5.90	15,498,501.56	60,622.28	15,559,123.84
Camps/Cassidy Lake	5.70	15,033,086.69	8.98	15,033,095.67
Michigan Training Unit	3.28	8,671,441.73	0	8,671,441.73
Michigan Reformatory	5.80	15,287,132.12	0	15,287,132.12
Muskegon Correc. Facility	3.06	8,053,961.23	0	8,053,961.23
Office of Health Care	10.30	27,096,853.30	31,409.08	27,128,262.38
Special Maintenance	.48	1,058,159.20	196,396.02	1,254,555.22
TOTALS	100.00	262,463,070.80	1,030,241.35	263,493,312.15

G2 EXCLUDING RIOT, ENCUMBERANCES AND CAPITOL OUTLAY / 83-84

Objects of Expenditures	Amount	Percent
Salaries & Wages	150,728,449.99	57.43
Longevity & Insurance	20,218,585.48	7.70
Retirement & FICA	32,487,693.49	12.38
Fuel	1,931,634.49	.74
Travel	1,725,906.39	.66
Equipment	1,786,030.25	.68
Utilities	8,712,302.81	3.32
Food	8,436,805.51	3.21
Rent - State-Owned Facilities	289,275.11	.11
Rent - Privately-Owned Facilities	2,276,459.97	.87
Insurance & Bonds*	2,709,224.75	1.03
Clothing & Textiles	2,426,414.93	.92
Household & Laundry	2,232,339.57	.85
Maintenance Supplies	2,929,916.86	1.12
Grants & Transfers	(1,033,430.52)	(.39)
CSS&M	24,605,461.72	9.37
TOTALS	262,463,070.80	100.00%

*Primarily Workers Compensation.

PERSONNEL

One chart in this section shows a comparison of minorities and females in the work force.

HI PERSONNEL REPORT 1984

AGENCY	TOTAL EMPLOYEES	NUMBER OF FEMALES	GOAL 41.5%	FEMALES CO'S	MINORITIES NO. %	GOAL AS A %	MINORITY GOAL
Cassidy Lake	74	17	31	5	21 28.4	17.9	13
Central Office	391	205	162	1	76 19.4	22.6	88
Field Services	881	394	366	24	242 27.5	22.6	199
Camp Program	278	49	115	17	27 9.7	17.9	50
Muskegon Correctional Facility	205	60	85	20	54 26.3	36.0	74
Michigan Training Unit	217	46	90	18	37 17.1	17.6	38
Marquette	398	56	165	17	29 7.3	5.3	21
M.I.P.C.	26	2	11	2	0 0.0	0.0	0
Michigan Reformatory	362	56	150	25	42 11.6	17.9	64
Southern Michigan Prison	1,483	330	615	141	215 14.5	18.5	274
Industries	109	13	45	0	18 16.5	18.5	20
Huron Valley Women's	200	158	83	105	86 43.0	17.9	36
Riverside Corr. Facility	485	122	201	40	57 11.8	17.6	85
Kinross Correctional Facility	293	50	122	14	22 7.5	10.3	30
Dunes Correctional Facility	180	48	75	15	25 13.9	15.2	27
Phoenix Correctional Facility	164	53	68	28	87 53.0	53.9	88
Huron Valley Men's	303	81	126	30	98 32.3	17.9	54
TOTAL	6,049	1,740	2,510	502	1,136 18.8	16.0	968

AFFIRMATIVE ACTION ACTIVITIES

RACE	MALE		FEMALE		TOTAL	
	NUMBER	PERCENT	NUMBER	PERCENT	NUMBER	PERCENT
White	3,667	84.9	1,246	72.0	4,913	81.0
Black	540	12.5	444	25.6	984	16.0
Indian	51	1.2	15	0.9	66	1.0
Hispanic	40	0.9	18	1.0	58	1.0
Asian	20	0.5	8	0.5	28	0.0
TOTAL	4,318	71.4	1,731	28.6	6,049	100.0

COMPARISON PERCENTAGE OF MINORITIES & FEMALES IN WORKFORCE

	1982 Sept.	1984 Oct.	1984 Nov.	1984 Dec.
Minority	15.7	17.9	18.7	18.8
Female	26.5	27.8	28.4	28.6

HANDICAP NUMBER PERCENT

Males	20	0.3
Females	10	0.2
TOTALS	30	0.5

H2 Minority Employees and Percentages

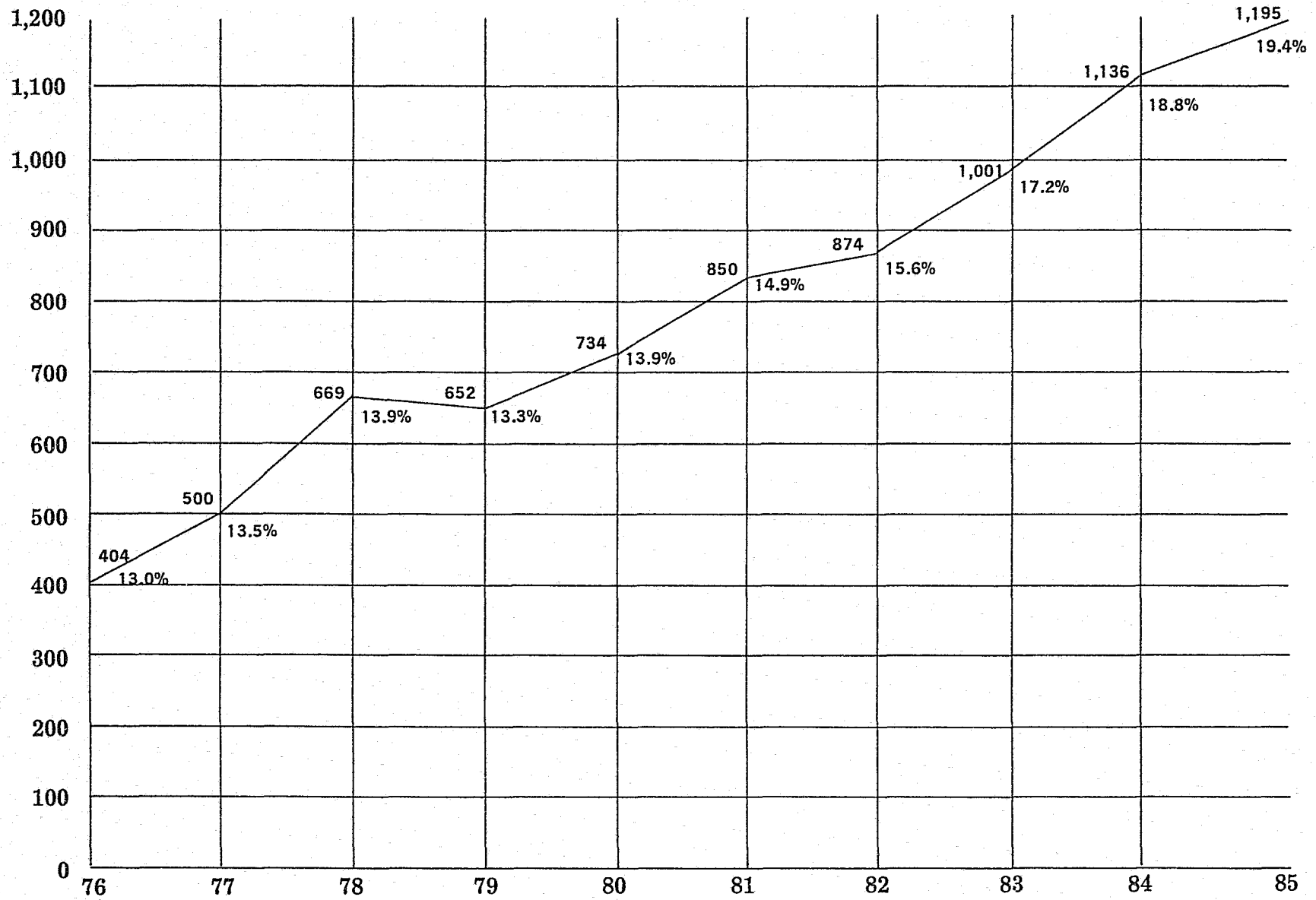

H3 Female Employees and Percentages at the Administrative and Professional Level

08

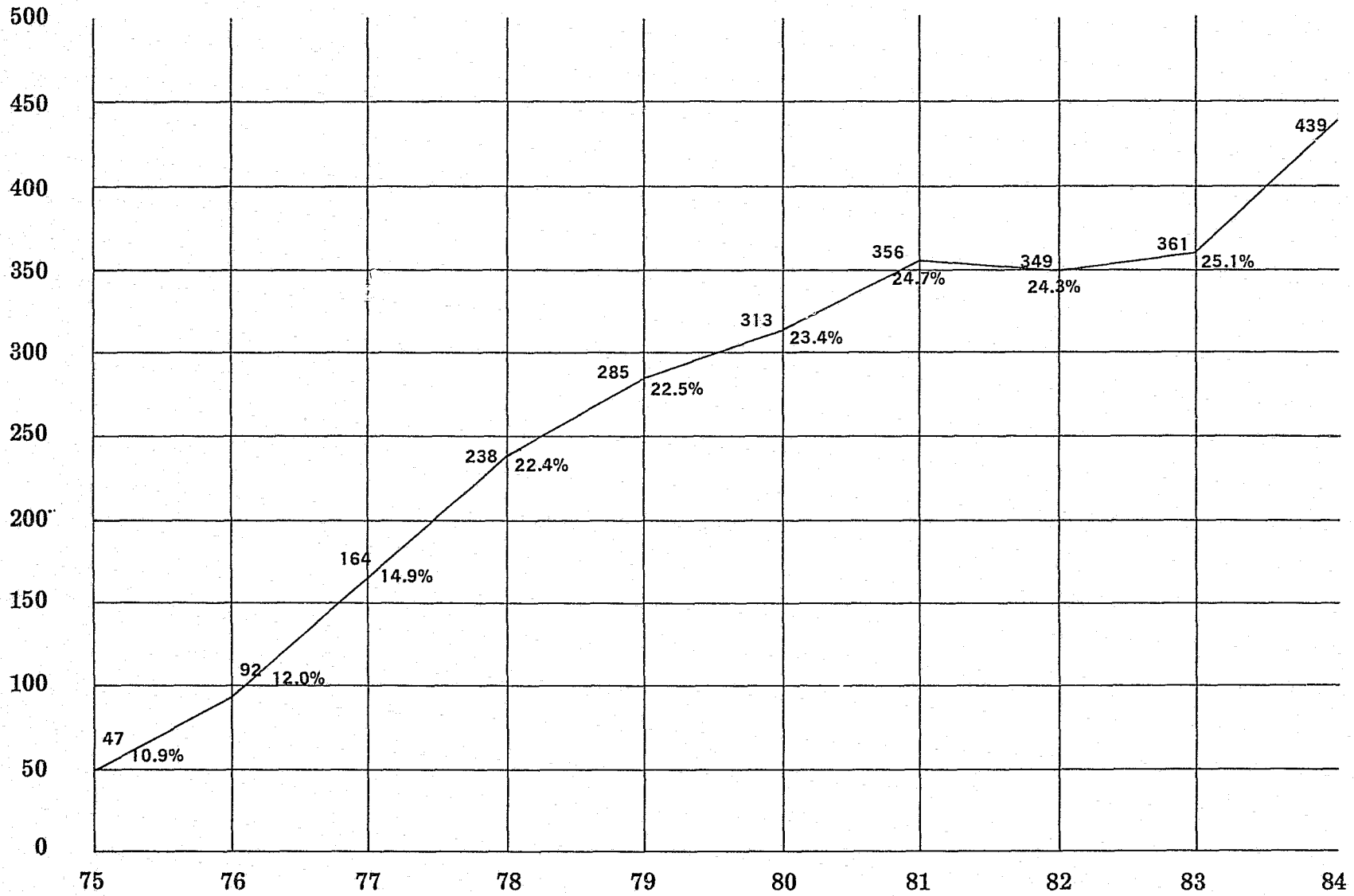

H4 Numbers of Female Corrections Officers from 1976 Dec. 31, 1984

81

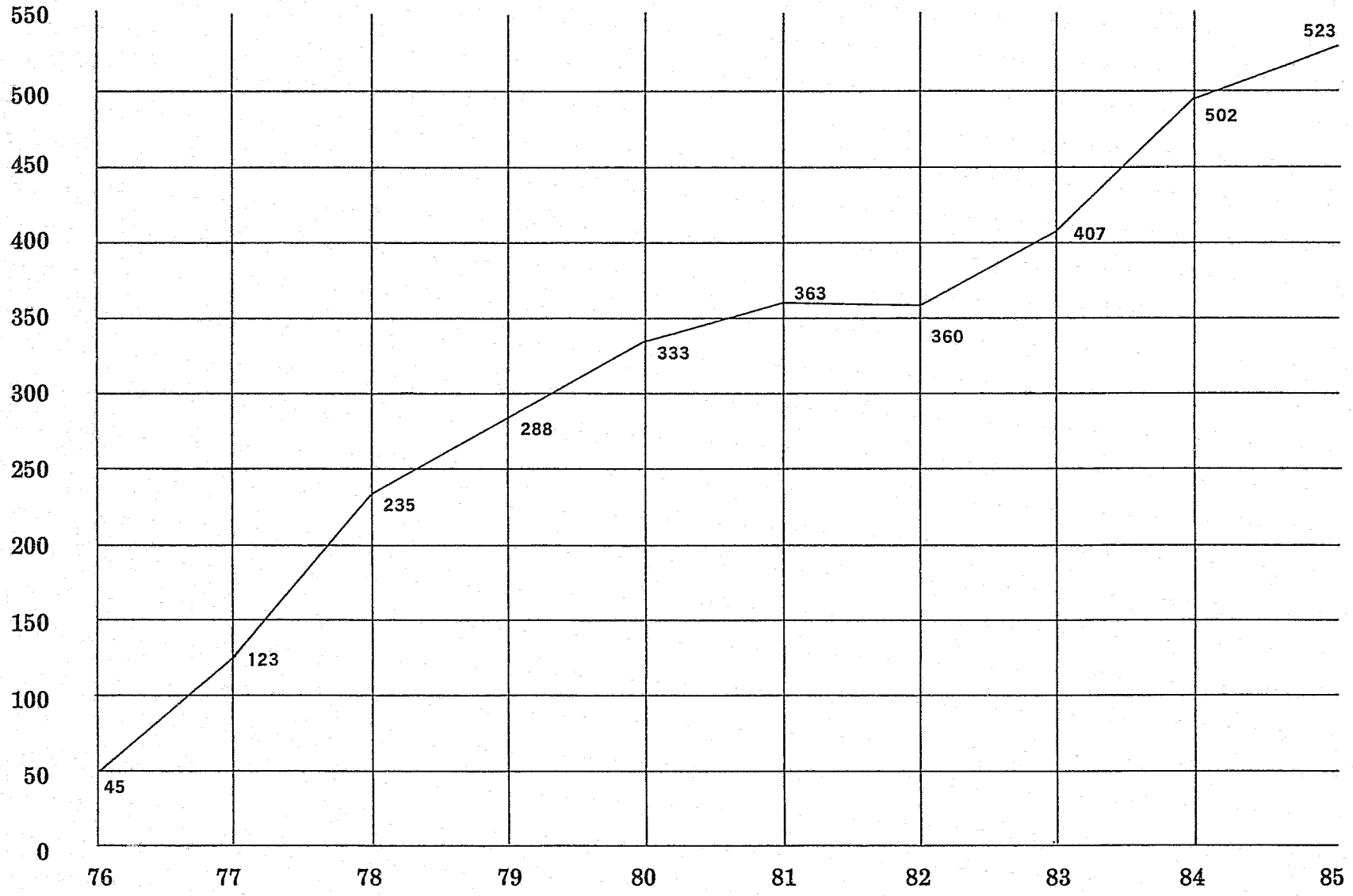

H5

COMBINED MALE, FEMALE & MINORITIES AT ADMINISTRATIVE & PROFESSIONAL LEVELS AS OF DECEMBER, 1984.

Institution Name	(1) Males (Non-Min.)	(2) Males (Minority)	(3) Total Males	(4) Females (Non-Min.)	(5) Females (Minority)	(6) Total Female	Total Minorities Male & Female	Total Male & Female
Central Office & Field Services	450	96	546	160	69	229	165	750
Camp Program	27	4	31	1	2	3	6	34
Cassidy Lake	13	6	19	9	1	10	7	29
Muskegon Corr.	27	5	32	10	2	12	7	44
Marquette Branch	33	4	37	14	0	14	4	48
MTU	38	4	41	9	0	9	4	50
Mich. Ref.	42	8	50	3	0	3	8	53
SPSM	122	24	146	30	8	38	29	174
Industries	11	3	14	2	0	2	3	16
Huron Valley Wom's	15	4	19	12	8	20	12	39
Riverside Corr.	52	10	62	27	6	33	16	88
Kinross	32	2	34	10	0	10	2	43
Dunes	19	3	22	10	0	10	3	31
Phoenix	11	3	14	4	1	5	4	18
Huron Valley Men's	17	6	23	17	4	21	11	42
TOTALS	905	192	1126	219	99	439	222	1467

LITIGATION RECEIVED EACH YEAR BY CATEGORY

Total judgments paid to plaintiffs by Department in 1984: \$748,158.52 (1) (This involved 58 cases)

Category	Through	1976	1977	1978	1979	1980	1981	1982	1983	1984	Total
Challenge to Conviction		67	119	140	129	144	176	201	150	153	1279
Access to Courts		6	16	1	14	16	11	20	18	11	113
Assault/Failure to Protect		23	15	17	27	43	50	40	71	49	335
Conditions of Confinement		-	-	7	6	26	67	27	51	63	247
Discipline		13	13	62	139	93	45	34	31	57	487
Discrimination/Harassment		12	19	13	21	12	14	17	8	18	134
Grievance Procedure		-	-	-	-	-	1	1	2	-	4
Gilty But Mentally Ill		-	-	1	-	1	-	1	-	-	3
Jail Services		-	-	3	1	1	2	-	1	3	11
Mail/Publication		5	8	11	8	9	6	5	9	12	73
Medical		27	32	34	31	38	32	42	34	41	311
Parole Release		8	16	30	39	31	17	18	25	22	206
Parole Revocation		5	9	13	11	14	5	15	9	19	100
Petitions under APA		-	-	-	2	104	504	435	462	110	1617
Prison Sites		-	-	-	-	-	1	-	-	-	1
Programming		4	10	18	47	36	20	24	11	60	230
Property (4)		6	4	3	14	15	31	124	58	53	308
Religion		7	14	3	5	6	4	12	10	8	69
Security Classification		45	44	61	78	62	48	112	54	54	558
Sentencing		-	-	-	-	35	18	11	11	23	98
Visits		3	4	2	4	10	8	7	5	1	44
Miscellaneous		-	-	-	-	-	1	17	23	32	73
Employee Suits		2	2	3	8	12	15	17	20	16	95
Personal Injury (Prisoners & Visitors)(2)									26	25	51
Court Claims (3)		19	22	32	43	46	81	44	*	*	287
FOIA		2	16	11	28	35	29	37	45	41	244
TOTAL		254	363	465	655	789	1186	1261	1134	871	6978

- (1) Breakdown of total:
 Judgments interest, court costs - \$482,143.70
 Payments to attorneys (fees paid by the Department to attorneys employed by prisoners) - \$266,014.82
 Filing Fee - \$40.00
- (2) Logged under Court of Claims from 1976 through 1982
- (3) *Category discontinued 1-83
- (4) Some property cases were logged in Court of Claims category (through 1981).